



LAPAROSCOPY

REDA

INSTRUMENTE GMBH



Laparoscopes	1
Trocar sleeves and accessories	2
Forceps	3
Scissors and biopsy forceps	4
Needleholder and suture instruments	5
HF-Instruments and accessories	6
Suction-Irrigation-Systems and accessories	7
Cholangiography	8
Palpation and retractors	9
Pediatric instruments	10
Thoracic instruments	11
Gynecology instruments	12
Urology retractor	13
Light Cable and connectors	14
Cameras and Light Sources	15
Pump Systems and accessories	16
Insufflators and accessories	17
Monitors and Trolley	18

Preface

This is a short listing of the groups of medical devices at the different chapters.
The intended use of those product groups are description in the glossary.

Handles with HF-connection
HF-connectors
Cannulas
Suction and Irrigation Instruments

Laparoscopes

Containing Devices:: Laparoscope

Trocar Sleeves and Accessories

Containing Devices:: Trocars
Trocar sleeves

Grasping Forceps

Containing Devices: Tube Shafts
Forceps
Clamps
Handles with HF-connections

Biopsie

Containing Devices: Handles with HF-connections
Scissors

Needle Holder

Containing Devices: Needle Holder
Handles with HF-connections
Forceps

HF Instruments

Containing Devices: HF-electrodes
Electrode handle
Connecting Cables
Connecting parts

Suction- and Irrigation Instruments

Containing Devices: Suction and irrigation instruments containing

- Handle
- Tube
- Guide insert
- different needles

Cholangiography

Preface

For cholangiography tubes, guide probes, cholangiography-catheters and fixation clamps are used. This system is used for diagnosis in the biliary ducts.

Containing Devices: Tubes
Guide Probes
Cholangiography-Catheters
Fixation Clamps

Palpation and Retractors

Containing Devices: Palpations
Retractors
Specula

Diagnostic and Pediatric

Containing Devices: Laparoscopes
Trocars
Forceps

Thorax

Containing Devices: Hysteroscopes
Trocars
Trocar Sleeves
Clamps
Forceps

Gynecology

Containing Devices: Applicators
Trocars
Trocar Sleeves
Clamps
Forceps
Myoma Drills
Cannulas

Urology

Containing Devices: Retractors

Light Sources

Containing Devices: Light source

Video System

In case of demand please contact us.

Suction and Irrigation Devices

Preface

The listed products are limited to accessories of suction and irrigation instruments. The respective instruments themselves are listed in chapter 7.

Containing Devices: Purgator
Tubes
Glasses / Cups
Suction Lids

CO²-Insufflator

Containing Devices: Devices for Insufflation
Accessories for the Device

Video Trollys

In case of demand please contact us.

Annex

Chapters

Glossary containing the intended use of the products / product groups.

Labels and Symbols showing the labels for class I, class II and implantable class II devices according to 93/42/EC, annex IX.



Explanation of the used Symbols according to ISO 15233:2007.

Device	Intended Use
Applicators	Application is the insert of material into the body. Applicators are supporting devices for hard accessible areas
CO²-Insuflator	Uncovering of the laparoscopy application field in the respective hollow organs by in insufflation of CO ² gas
HF-connections	The HF connections prevent irritating pivoting motions aids well-balance handling
Hysteroscope	optical devices for the gynaecological diagnoses and/or operation
Instruments for HF-Surgery	cut and/or coagulate tissue by HF-voltage
Clamps	clamps grasp different material like tissue or skin
Laparoscopes	Laparoscopes are optical devices for diagnosis and surgical operations in abdominal and pelvic cavities
Myoma Drill	removal of myomas after a laparoscopic myomectomy
Needle Holder	Needle holder grasp, hold and guide surgical needles during the suture
Devices for Cholangiography	For cholangiography tubes, guide probes, cholangiography-catheters and fixation clamps are used. This system is used for diagnosis in the biliary ducts
Retractors	Spreading instruments to fix tissue or vessels etc. at surgical body orifice and wounds for free access to the operation area
Suction and Irrigation Instruments	Suction and irrigation instruments remove fluid out of the operation area during a biopsy
Scissors	Scissors are cutting instruments to separate materials like tissues, skin, suture and dressing material, plasters and/or bones.
Cannulas	Cannulas are diagnostic instruments used to examine and/or record body functions and/or structures
Specula	Spreading instruments to fix tissue or vessels etc. at surgical body orifice and wounds for free access to the operation area
Palpations	Palpations are used for diagnosis of body functions at areas with difficult access
Trocars	Trocars are piercing the skin to enable access to the operating field
Trocar Sleeves	Trocar sleeves are used together with trocars and enable MIS at the operating field after removal of the trocar
Forceps	Forceps grasp different material like tissue or skin
Light Source	light cable with adapters for its connection to different endoscopes

1. Form for Labels of Class I Products according to 93/42/EWG, Annex IX



Gänsäcker 34 - 78532 Tuttingen - Germany
Phone +49 7462 94450 Fax +49 7462 944520

Name	Kundenname	
Customer	: Kundennummer	
Ordner No.	: Bestellnummer	
Conf. No.	: Auftragsnummer	
REF	: Katalognummer	
Quantity	: xx pcs LOT	
Cust.-Art.	: Kundenartikelnummer	
Descript.	: Kundenartikelbeschreibung	

Etching





00277750022000020

LBL-001 Rev.01

2. Form for Labels of Products higher than Class I according to 93/42/EWG, Annex IX



Gänsäcker 34 - 78532 Tuttingen - Germany
Phone +49 7462 94450 Fax +49 7462 944520

Name	Kundenname	
Customer	: Kundennummer	
Ordner No.	: Bestellnummer	
Conf. No.	: Auftragsnummer	
REF	: Katalognummer	
Quantity	: xx pcs LOT	
Cust.-Art.	: Kundenartikelnummer	
Descript.	: Kundenartikelbeschreibung	

Etching



00277750022000020

LBL-002 Rev.01

3. Form for Labels of implantable Class II Products according to 93/42/EWG, Annex IX



Gänsäcker 34 - 78532 Tuttingen - Germany
Phone +49 7462 94450 Fax +49 7462 944520

Name	Kundenname	
Customer	: Kundennummer	
Ordner No.	: Bestellnummer	
Conf. No.	: Auftragsnummer	
REF	: Katalognummer	
Quantity	: xx pcs LOT	
Cust.-Art.	: Kundenartikelnummer	
Descript.	: Kundenartikelbeschreibung	

Etching



00277750022000020

LBL-003 Rev.01

Explanation of the used Symbols



Explanation of the symbols can be seen in the accompanying document



Address of the manufacturer



Reference Number



Lot Number / Serial Number



Take account to the warnings in the accompanying document



Non-sterile



Single use produkt



CE-symbol for class I devices according to 93/42/EC, annex IX



CE-symbol for class I devices according to 93/42/EC, annex IX

IMPORTANT INFORMATION CONCERNING PREPARING AND STERILIZING SURGICAL INSTRUMENTS

Dear Sirs,
please read the following instructions very carefully before using the instruments.

1. INITIAL USE

All instruments which are being used for the first time must be thoroughly cleaned, rinsed and then sterilized before using.

2. TREATING INSTRUMENTS AFTER USAGE

- a.) The instruments might be immediately thoroughly cleaned and disinfected. Please follow the manufacturer's instructions when using cleaning agents and disinfectants.
- b.) Instruments which may be dismantled must be cleaned and disinfected after being taken apart.
- c.) Cleaning may be carried out either manually or with a machine. Care should be taken that only cleaning agents and disinfectants are used, which are changed daily.
- d.) Following chemical disinfection and manual cleaning, all instruments must always be thoroughly rinsed under running water.
- e.) The temperature of water used in a machine for cleaning should not exceed 45°C.
- f.) Whether cleaning is carried out manually or by machine, we especially ask you to ensure that the correct dosage for cleaning solutions or the correct combination of disinfectant and cleaning solution, is employed. Similar importance should be applied to the length of time the agents require to perform properly and to the temperature set.
- g.) Hinged instruments should be opened before cleaning.
- h.) Please ensure that the perforated instrument trays, when loaded, do not exceed 10 kg in weight.
- i.) Please take care that when instruments are being cleaned they are arranged proper in a manne that fluids can circulate freely.
- j.) Deposits remaining after the cleaning process must be completely removed in the first rinse which now follows. The optimum temperature for final rinsing has proved to be between 70° and 90° C. Please use only purified water in this final cleaning stage.
- k.) The instruments must be carefully dried after cleaning and rinsing is completed.
- l.) Moving parts and the cutting edges of shears and scissors must be treated with preservatives which are both suitable and physiologically safe.

3. TESTING FOR CORRECT FUNCTIONING

- a.) Instruments must be carefully and thoroughly checked before every occasion that they are used.
- b.) After each time they are cleaned, the instruments must be macroscopically clean, i.e., visibly free from proteinbased residues and other soiling.
- c.) Care should be taken so that cracks, breakages and corrosion are noticed.
- d.) Instruments with flecks should be separated and taken out for special treatment.

- e.) All moving parts as well as working tips and blades should be checked with special care.
- f.) Checking should be carried out according to the extent to which the instruments will be used.
- g.) Instruments which are in any way defective or damaged should be immediately sorted out from the others.

4. STERILIZATION

- a.) All stainless steel surgical instruments supplied by us may be sterilized in an autoclave.
- b.) Please follow the manufacturer's operating instructions when using autoclave. All machines used must comply with all current quality and other standards.
- c.) Instruments are being sterilized/ autoclaved at a temperature of 134°C.
- d.) Sterilization packing material must comply with all current standards.
- e.) Instruments with ratchets or self-retaining mechanisms should be sterilized opened or in the first ratchet position.
- f.) Please ensure that perforated instrument trays, when loaded do not exceed 10 kg in weight.

5. IN GENERAL

- a.) All surgical instruments supplied by us have been thoroughly inspected before dispatch and leave our factory in perfect condition. Damage which can arise as a result of transporting, cleaning, preserving, sterilizing or storing, must be prevented.
- b.) Please handle surgical instruments always with the utmost care.
- c.) Instruments must be stored in a clean and dry place.
- d.) If you have any queries or problems please contact us at any time:

We should like to point out that, if the above-mentioned directions are not followed or the instruments supplied by us are not properly used, all guarantee claims become void and any consequences must be borne by yourselves.

REV. 2005/01

Laparoscopes with integrated fiberoptic for illumination, autoclavable suitable for HD Systems



Compatibility

Light port adapter	ACMI [®] -, Wolf [®] -, Storz [®] / Olympus [®]
Eyepiece	Ocular according DIN 58105 threaded
Objective	Tension-free objective composed-objective
Image transmission	CAD-designed rodence system for optimal sharpness, colorsync and resolution
Light-guiding system	High quality light fibers
Optical glass	Distal and proximal Sapphire
Biocompatibility	All materials that come in contact with the body are biocompatible. All outside metal parts are made of high quality stainless steel.

Ø	working length	direction of view	
		0°	30°
5,0 mm	302 mm	R010-050302-000	R010-050302-030
10,0 mm	310 mm	R010-100309-000	R010-100309-030
10,0 mm	350 mm	R010-100350-000	R010-100350-030

Operating-Laparoscopes with working channel, integrated fiberoptic for illumination Parallel eye piece (2 x 90°)



Compatibility

Light port adapter	ACMI [®] -, Wolf [®] -, Storz [®] / Olympus [®]
Eyepiece	Ocular according DIN 58105 threaded
Objective	Tension-free objective composed-objective
Image transmission	CAD-designed rodence system for optimal sharpness, colorsync and resolution
Light-guiding system	High quality light fibers
Optical glass	Distal and proximal Sapphire
Biocompatibility	All materials that come in contact with the body are biocompatible. All outside metal parts are made of high quality stainless steel.

Ø outer tube	working length	working channel Ø	direction of view
10,0 mm	266,3 mm	6,0 mm (18 Char.)	0°
			R011-100273-060

Only instruments with min. 420 mm working length are convenable for use.

Operating-Laparoscopes with working channel, integrated fiberoptic for illumination 45° angled view



Compatibility

Light port adapter	ACMI [®] -, Wolf [®] -, Storz [®] / Olympus [®]
Eyepiece	Ocular according DIN 58105 threaded
Objective	Tension-free objective composed-objective
Image transmission	CAD-designed rodence system for optimal sharpness, colorsync and resolution
Light-guiding system	High quality light fibers
Optical glass	Distal and proximal Sapphire
Biocompatibility	All materials that come in contact with the body are biocompatible. All outside metal parts are made of high quality stainless steel.

Ø outer tube	working length	working channel Ø	direction of view
10,0 mm	266,3 mm	6,0 mm (18 Char.)	0°
			R012-100273-060

Only instruments with min. 420 mm working length are convenable for use.

Endoscope

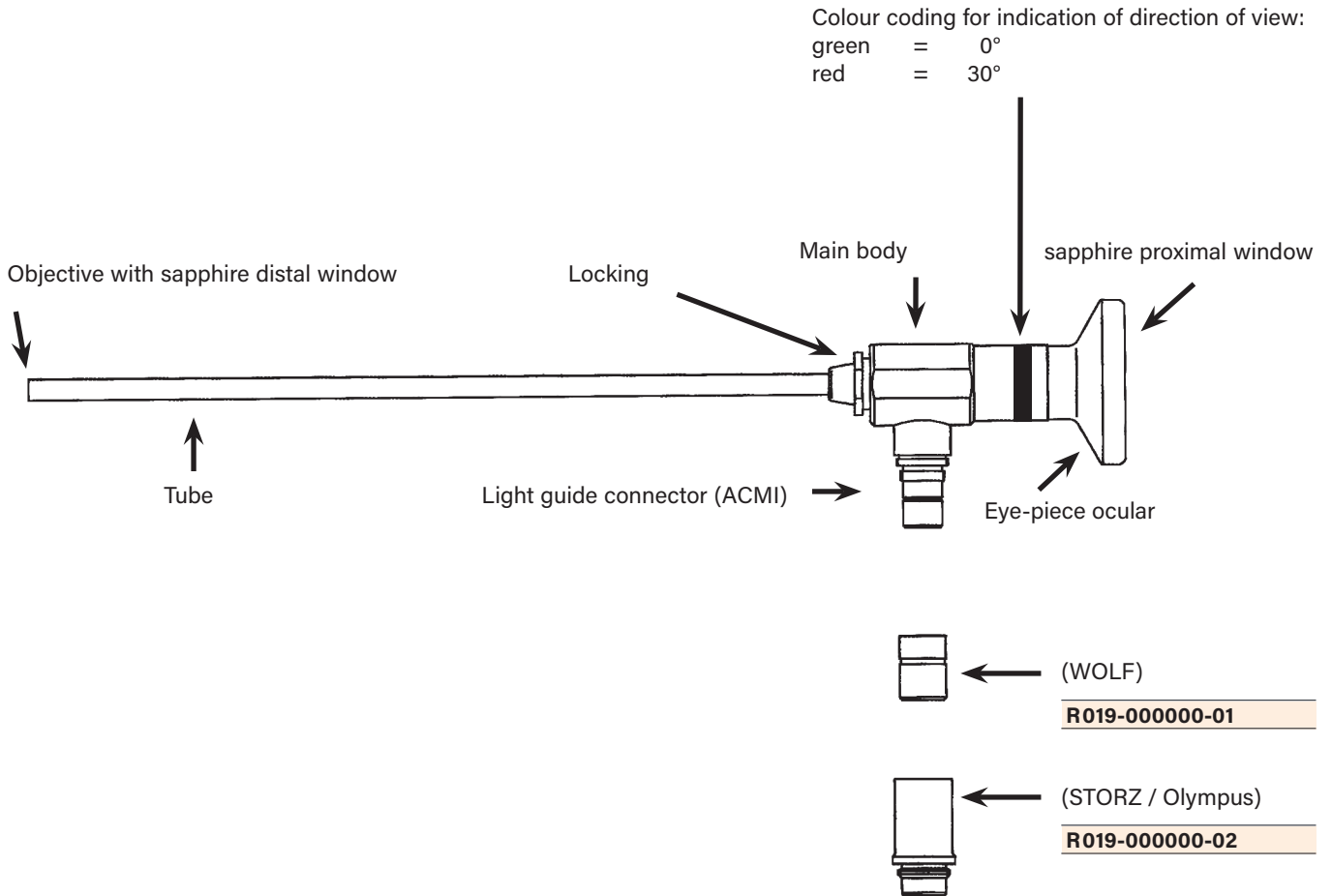



Anti Fog liquid Ultra Stop 25ml non sterile

R019-000000-025



Anti Fog liquid Ultra Stop sterile incision bottle 30ml

R019-000000-030



Cleaning paste, 6gr. f. distal and proximal windows and fiber optic port of endoscopes

98002-06

Wire basket for endoscopes

Container for Endoscopes

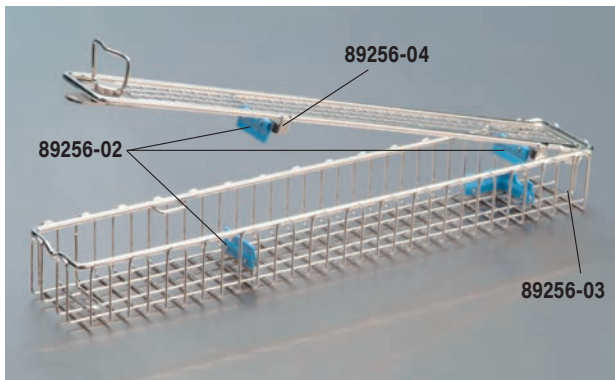

460 x 80 x 52 mm
for 1 laparoscope or 1 hysteroscope or 1 cystoscope

89256-46

460 x 80 x 52 mm
for 2 laparoscopes or 2 hysteroscopes or 2 cystoscopes

89257-46

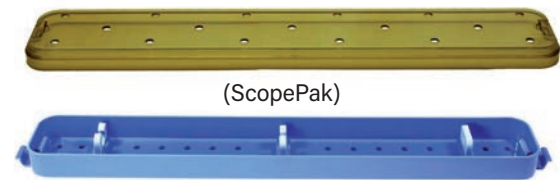

(ScopePak)

432 x 76 x 33 mm
for 1 hysteroscope or 1 cystoscope

R019-9317

511 x 76 x 33 mm
for 1 laparoscope

R019-9321

813 x 132 x 79 mm
for 1 extra long endoscope

R019-9331

Storage- and sterilization rack

Endoscope Basket (with stand)

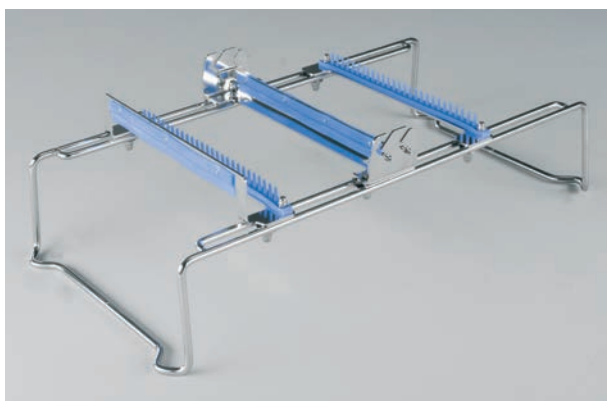

470 x 250 x 125 mm
5 / 10 mm Ø
for 15 MIS instruments suitable for container R 110.20

89258-47

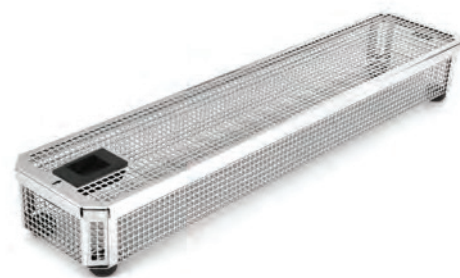

Outside dimensions 500 x 135 x 50 mm

89450-50

Containers for Endoscopy

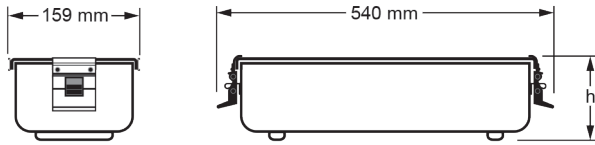

540 x 159 x 80 mm

540 x 159 x 80 mm

R 614.08	R 614.10
R 624.08	R 624.10
R 634.08	R 634.10
R 644.08	R 644.10
R 654.08	R 654.10
R 664.08	R 664.10



Containers for Endoscopes
(with silicone stand, lock and label)

270 x 70 x 65 mm



475 x 80 x 65 mm



R 516.07	R 517.07
R 526.07	R 527.07
R 536.07	R 537.07
R 546.07	R 547.07
R 556.07	R 557.07
R 566.07	R 567.07



R 516.08	R 517.08
R 526.08	R 527.08
R 536.08	R 537.08
R 546.08	R 547.08
R 556.08	R 557.08
R 566.08	R 567.08

S-retractor



7 mm / 2 pcs.	10 mm / 2 pcs.	13 mm / 2 pcs.	16 mm / 2 pcs.
R020-000000-007	R020-000000-010	R020-000000-013	R020-000000-016

Ø 5 mm

Multi function trocar sleeve,
valvehousing with thread lock

R025-050092-001

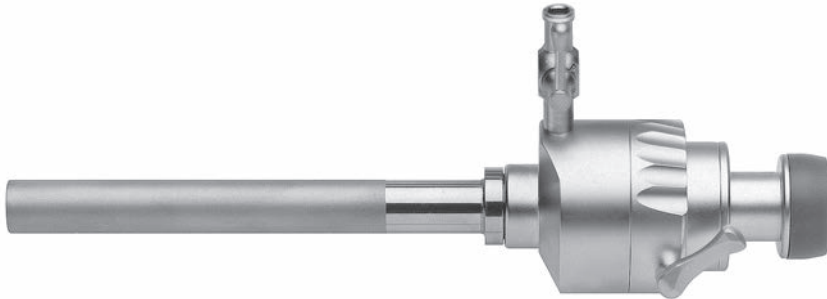

Trocar stop

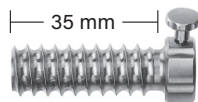

R020-050035-001

Dilation set



5 < 10 mm

5 < 11 mm

R027-050100-000

R027-050110-000

Rubber washer for proximal instrument port suitable to lap. trocar sleeves / 10 pcs per box



Ø 5,0 mm

R020-050000-004

Spare part set consisting of 10 pcs per box



Ø 5,0 mm

R022-050000-000

Ø 5 mm

Standard trocar



pyramidal

R020-050092-001



conical

R020-050092-002

Standard trocar with hole, permeable



pyramidal

R020-050092-051



conical

R020-050092-052

Safety trocar with automatic locking



with pyramidal grinding and rounded tip

R020-050092-011



with halfmoon grinding and oblique tip

R020-050092-016

Protection trocar



with halfmoon grinding and oblique tip

R020-050092-024



with halfmoon grinding and V-formed tip

R020-050092-025

Reducer sleeve 5 > 4 mm



R026-055030-003

Ø 5,5 mm

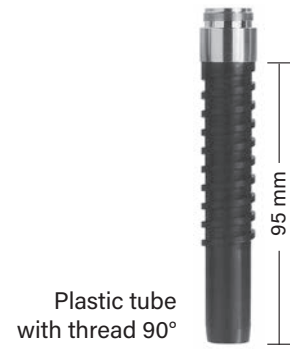
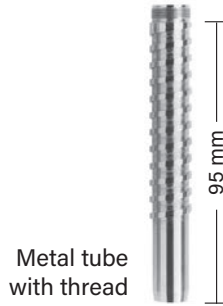
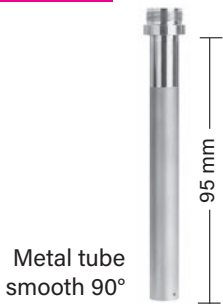

Drap door valve trocar sleeve



R022-055095-001

R022-055098-002

R022-055095-003

R022-055098-004

Silicone valve trocar sleeve

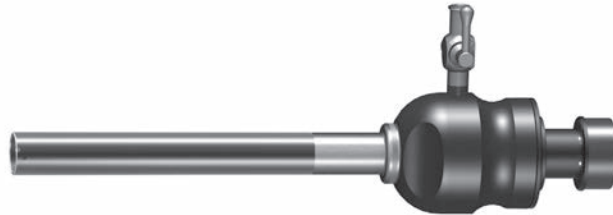

R024-055095-001

Multi function trocar sleeve, valvehousing with thread lock



R025-055095-001

R025-055098-002

R025-055095-003

R025-055098-004

Trocar stop

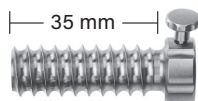

R020-055035-001

Rubber washer for proximal instrument port suitable to lap. trocar sleeves / 10 pcs per box



Ø 5,5 mm

R020-050000-004

Spare part set consisting of 10 pcs per box



Ø 5,5 mm

R022-055000-000

Ø 5,5 mm

Standard trocar



pyramidal

R020-055095-001



conical

R020-055095-002

Standard trocar with hole, permeable



pyramidal

R020-055095-051



conical

R020-055095-052

Safety trocar with automatic locking



with pyramidal grinding and rounded tip

R020-055095-011



with halfmoon grinding and oblique tip

R020-055095-016

Safety trocar with Knife



Obturator tip "KNIFE DESIGN"

R020-055095-028

Protection trocar



with halfmoon grinding and oblique tip

R020-055095-024



with halfmoon grinding and V-formed tip

R020-055095-025

Ø 5,5 mm / 150 mm WL

Drap door valve trocar sleeve

R022-055150-001

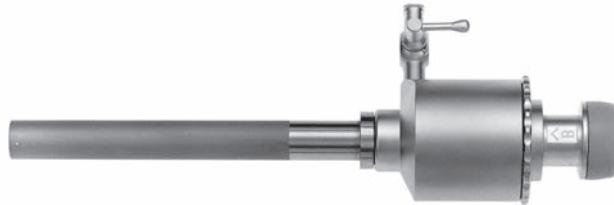

Silicone valve trocar sleeve

R024-055150-001

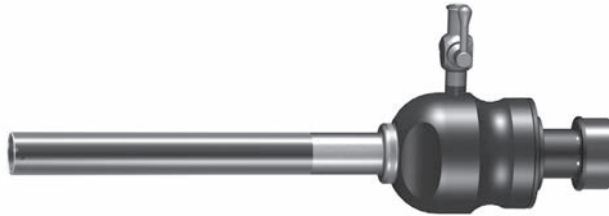

Multi function trocar sleeve,
valvehousing with thread lock

R025-055150-001

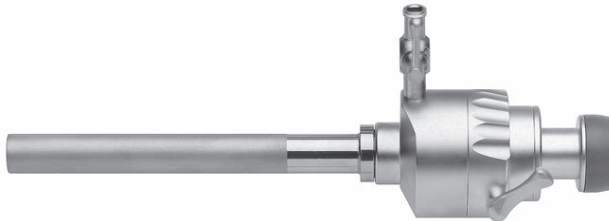

Rubber washer for proximal instrument port suitable to lap. trocar sleeves / 10 pcs per box



Ø 5,5 mm

R020-050000-004

Spare part set consisting of 10 pcs per box



Ø 5,5 mm

R022-055000-000

Ø 5,5 mm / 150 mm WL

Standard trocar



pyramidal

R020-055150-001



conical

R020-055150-002

Standard trocar with hole, permeable



pyramidal

R020-055150-051



conical

R020-055150-052

Safety trocar with automatic locking



with pyramidal grinding
and rounded tip

R020-055150-011

Ø 10 mm

Multi function trocar sleeve,
valvehousing with thread lock

R025-100097-001

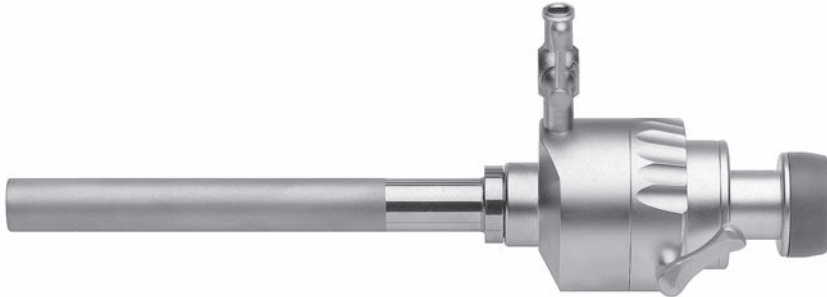

Trocar stop

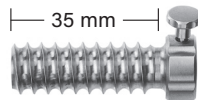

R020-100035-001

Rubber washer for proximal instrument port suitable to lap. trocar sleeves / 10 pcs per box

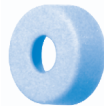

Ø 10,0 mm

R020-100000-008

Spare part set consisting of 10 pcs per box



Ø 10,0 mm

R022-100000-000

Reducer sleeve 10 > 5,5 mm

Plastic reducer for multi function trocar sleeve only



190 mm

R026-100055-003



reducer with silicone latch

R026-100055-002

Ø 10 mm

Standard trocar



pyramidal

R020-100097-001



conical

R020-100097-002

Standard trocar with hole, permeable



pyramidal

R020-100097-051



conical

R020-100097-052

Safety trocar with automatic locking



with pyramidal grinding and rounded tip

R020-100097-011



with halfmoon grinding and oblique tip

R020-100097-016

Protection trocar



with halfmoon grinding and oblique tip

R020-100097-024



with halfmoon grinding and V-formed tip

R020-100097-025

Ø 11 mm

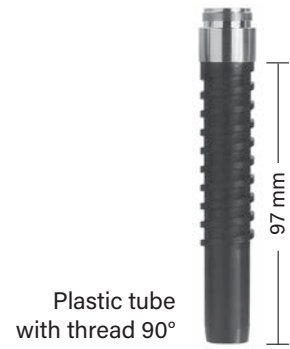
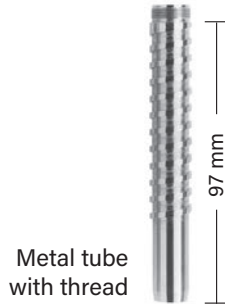
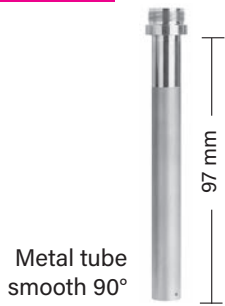

Drap door valve trocar sleeve



R022-110101-001

R022-110105-002

R022-110101-003

R022-110105-004

Silicone valve trocar sleeve

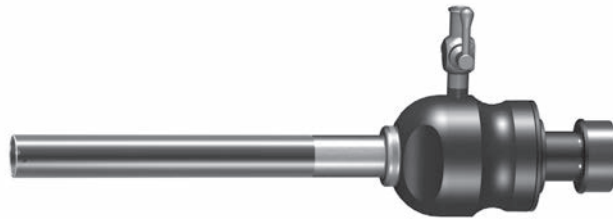

R024-110101-001

R024-110105-002

R024-110101-003

R024-110105-004

Multi function trocar sleeve, valvehousing with thread lock



R025-110101-001

R025-110105-002

R025-110101-003

R025-110105-004

Trocar stop

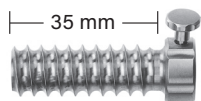

R020-110035-001

Rubber washer for proximal instrument port suitable to lap. trocar sleeves / 10 pcs per box

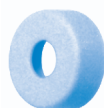

Ø 11,0 mm

R020-110000-009

Spare part set consisting of 10 pcs per box



Ø 11,0 mm

R022-110000-000

Ø 11 mm

Standard trocar



pyramidal

R020-110101-001



conical

R020-110101-002

Standard trocar with hole, permeable



pyramidal

R020-110101-051



conical

R020-110101-052

Safety trocar with automatic locking



with pyramidal grinding and rounded tip

R020-110101-011



with halfmoon grinding and oblique tip

R020-110101-016

Safety trocar with Knife



Obturator tip "KNIFE DESIGN"

R020-110101-028

Protection trocar



with halfmoon grinding and oblique tip

R020-110101-024



with halfmoon grinding and V-formed tip

R020-110101-025

Reducer sleeve 11 > 5,5 mm



190 mm

R026-110055-003

Plastic reducer for multi function trocar sleeve only



reducer with silicone Latch

R026-110055-002



R026-125055-004

Ø 11 mm / 150 mm WL

Drap door valve trocar sleeve

R022-110150-001



Silicone valve trocar sleeve

R024-110150-001

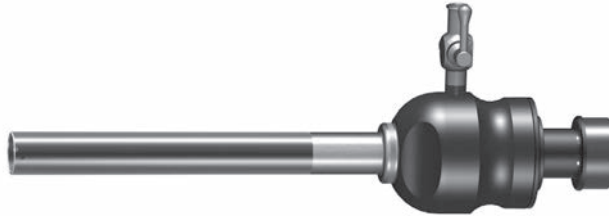

Multi function trocar sleeve,
valvehousing with thread lock

R025-110150-001

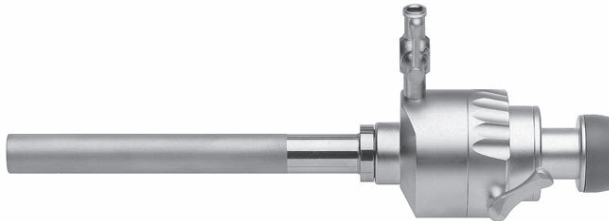

Rubber washer for proximal instrument port suitable to lap. trocar sleeves / 10 pcs per box

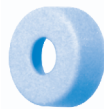

Ø 11,0 mm

R020-110000-009

Spare part set consisting of 10 pcs per box



Ø 11,0 mm

R022-110000-000

Ø 11 mm / 150 mm WL

Standard trocar



pyramidal

R020-110150-001



conical

R020-110150-002

Standard trocar with hole, permeable



pyramidal

R020-110150-051



conical

R020-110150-052

Safety trocar with automatic locking



with pyramidal grinding
and rounded tip

R020-110150-011

Ø 12,5 mm

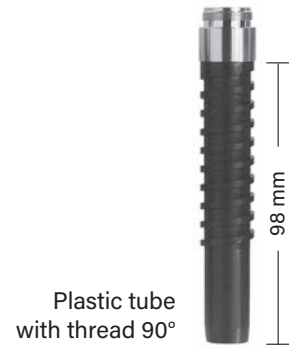
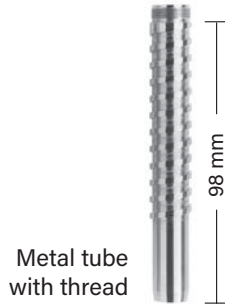
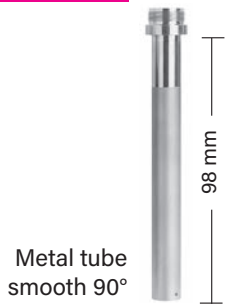

Multi function trocar sleeve, valvehousing with thread lock

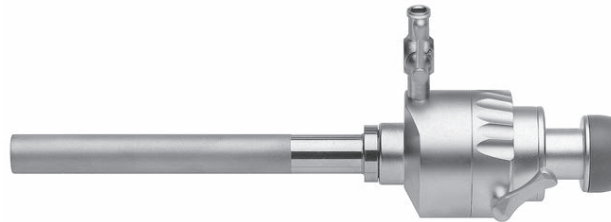

R025-125098-001

R025-125102-002

R025-125098-003

R025-125102-004

Trocar stop

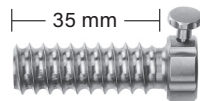

R020-125035-001

Rubber washer for proximal instrument port suitable to lap. trocar sleeves / 10 pcs per box

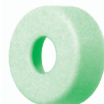

Ø 12,5 mm

R020-125000-011

Spare part set consisting of 10 pcs per box



Ø 12,5 mm

R022-125000-000

Reducer sleeve 12,5 > 5,5 mm

Plastic reducer for multi function trocar sleeve only



190 mm

R026-125055-003



reducer with silicone latch



12,5 > 10 mm

R026-125100-002

R026-125100-004

12,5 > 5,5 mm

R026-125055-002

R026-125055-004

Ø 12,5 mm

Standard trocar



pyramidal

R020-125098-001



conical

R020-125098-002

Standard trocar with hole, permeable



pyramidal

R020-125098-051



conical

R020-125098-052

Safety trocar with automatic locking



with pyramidal grinding and rounded tip

R020-125098-011



with halfmoon grinding and oblique tip

R020-125098-016

Safety trocar with Knife



Obturator tip "KNIFE DESIGN"

R020-125098-028

Protection trocar



with halfmoon grinding and oblique tip

R020-125098-024



with halfmoon grinding and V-formed tip

R020-125098-025

Ø 12,5 mm / 150 mm WL

Multi function trocar sleeve,
valvehousing with thread lock

R025-125150-001

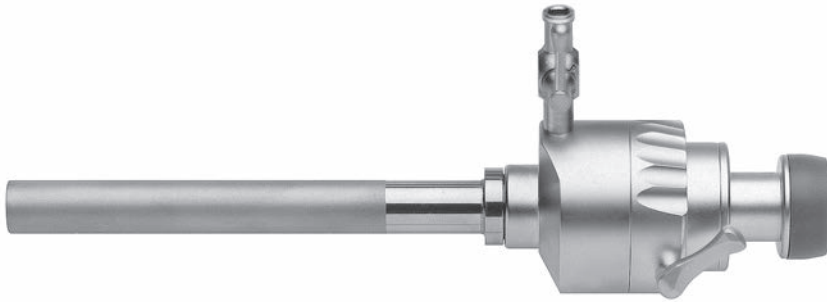

Rubber washer for proximal instrument port suitable to lap. trocar sleeves / 10 pcs per box

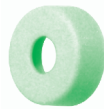

Ø 12,5 mm

R020-125000-011

Spare part set consisting of 10 pcs per box



Ø 12,5 mm

R022-125000-000

Ø 12,5 mm / 150 mm WL

Standard trocar



pyramidal

R020-125150-001



conical

R020-125150-002

Standard trocar with hole, permeable



pyramidal

R020-125150-051



conical

R020-125150-052

Safety trocar with automatic locking



with pyramidal grinding
and rounded tip

R020-125150-011

Ø 15 mm Automatic trocar sleeve with smooth metal tube, housing with winding locking and stopcock

Trocar sleeve, smooth metal tube

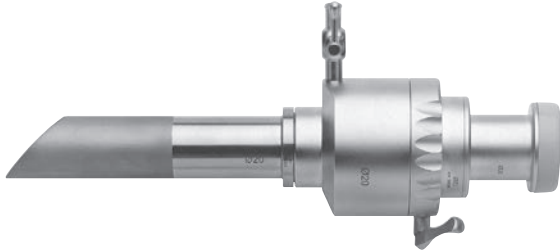

15 mm Ø / WL 110 mm

R025-150095-011

Standard trocar 15 mm Ø



pyramidal

R020-150096-001



conical

R020-150096-002

Dilatation sleeve with guide rod



Ø 5,0 mm - 15,0 mm

R027-050150-000

Ø 10,0 mm - 15,0 mm

R027-110150-000

Rubber washer for proximal instrument port suitable to lap. trocar sleeves / 10 pcs per box



Ø 15,0 mm

R020-150000-013

Spare part set consisting of 10 pcs per box



Ø 15,0 mm

R022-150000-000

Reducer sleeve



15 > 5,5 mm

R026-150055-003

15 > 10 mm

R026-150100-003

Ø 20 mm Automatic trocar sleeve with smooth metal tube, housing with winding locking and stopcock

Trocar sleeve, smooth metal tube

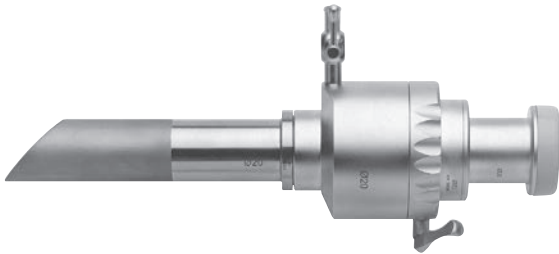

20 mm Ø / WL 119 mm

R025-200095-011

Standard trocar 20 mm Ø



pyramidal

R020-200096-001



conical

R020-200096-002

Dilatation sleeve with guide rod



Ø 5,0 mm - 20,0 mm

R027-050200-000

Ø 10,0 mm - 20,0 mm

R027-110200-000

Rubber washer for proximal instrument port suitable to lap. trocar sleeves / 10 pcs per box



Ø 20,0 mm

R020-200000-018

Spare part set consisting of 10 pcs per box



Ø 20,0 mm

R022-200000-000

Reducer sleeve



20 > 5,5 mm



R026-200055-003

20 > 10 mm

R026-200100-003

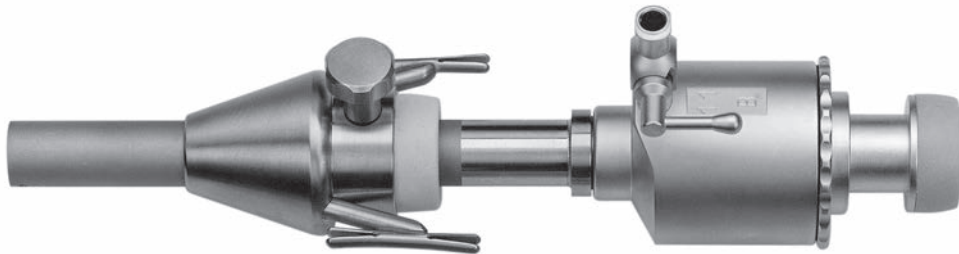
Hasson automatic trocar sleeve with stopcock, adjustable cone and suture holder at cone



Ø	Sleeve with Cone	 Cone alone	 Cone alone
3,5 mm		R020-035500-001	
5,5 mm	R028-055095-021	R020-055500-001	
11,0 mm	R028-110101-021	R020-110500-001	R020-110700-001
12,5 mm	R028-125098-021	R020-125500-001	

Standard trocar



conical blunt

R020-035070-003	Ø 3,5 mm
R020-055095-003	Ø 5,5 mm
R020-110101-003	Ø 11,0 mm
R020-125098-003	Ø 12,5 mm



Ø 5 und 10 mm



Mechanical snap-action coupling !

The Ø 5 and 10 mm modular REDA laparoscopic instruments have a unique snap-action coupling which, offering the combined advantage of the speediest possible assembly and a long service life.

The union of the working insert and sleeve shaft is achieved by simply inserting the components axially into each other. A simple click and you are ready!

The groove-and-tongue principle practically rules out the possibility of the locking mechanism coming undone, as is the case with conventional screw or bayonet connections.

REDA - simplicity is so clever !



Nut stopper

An nut on the sleeve shaft of REDA modular instruments prevents bothersome slipping or even the loss of the union nut.

REDA - detail is the decisive factor !

Ø 3 / 5 / 10 mm

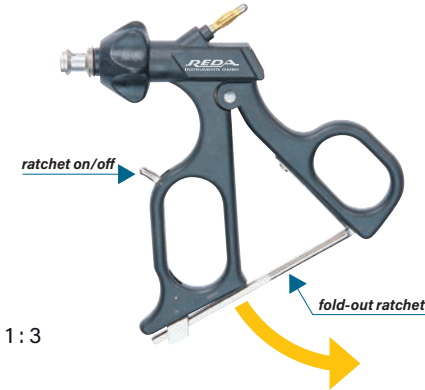

1:3

Ergonomic universal carbon handle with ratchet,
Lever for active or unactive ratchet, HF-connector Ø 4 mm male 45° lateral,
rotating head 360°, autoclavable

R033 - 000000 - 000



1:3

Ergonomic carbon handle with stepless ratchet,
ratchet by finger press resolve, HF-connector Ø 4 mm male 45° lateral,
rotating head 360°, autoclavable

R033P - 000000 - 000



1:3

Ergonomic carbon handle,
HF-connector Ø 4 mm male 45° lateral, rotating head 360°, autoclavable

R034 - 000000 - 000



1:3

Ergonomic universal carbon handle with ratchet,
Button for active or unactive ratchet, HF-connector Ø 4 mm male 45° lateral,
rotating head 360°, autoclavable

R032M - 000000 - 000

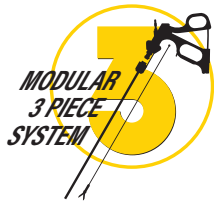

Laparoscopy -
Carbon Handles for Ø 3 / 5 / 10 mm tube shafts



Ø 3 / 5 / 10 mm

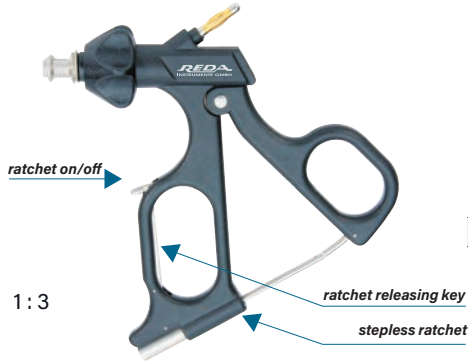

Ergonomic carbon handle with stepless ratchet,
ratchet activating / release lever, HF-connector Ø 4 mm male 45° lateral,
rotating head 360°, autoclavable

R033M - 000000 - 000

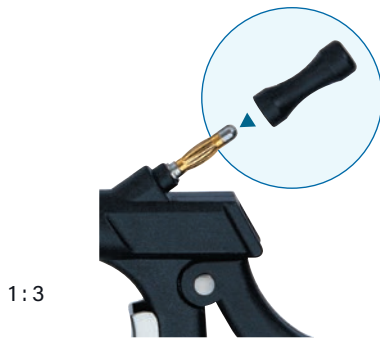

Protection cap for HF-connector Ø 4 mm

R030 - 000000

Ø 3 / 5 / 10 mm

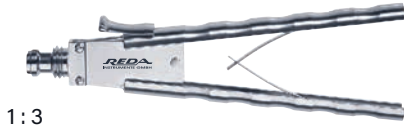

Axial handle, v-shaped type with spreading spring and ratchet

R038 - 000000 - 000

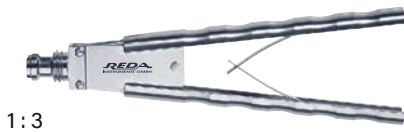

Axial handle, with spreading spring

R048 - 000000 - 000



Axial handle with rings and ratchet

R037 - 000000 - 000



Axial ring handle

R047 - 000000 - 000



Axial handle, v-shaped angled, type with spreading spring and ratchet

R039 - 000000 - 000



Axial handle, angled, with spreading spring

R040 - 000000 - 000

1



2

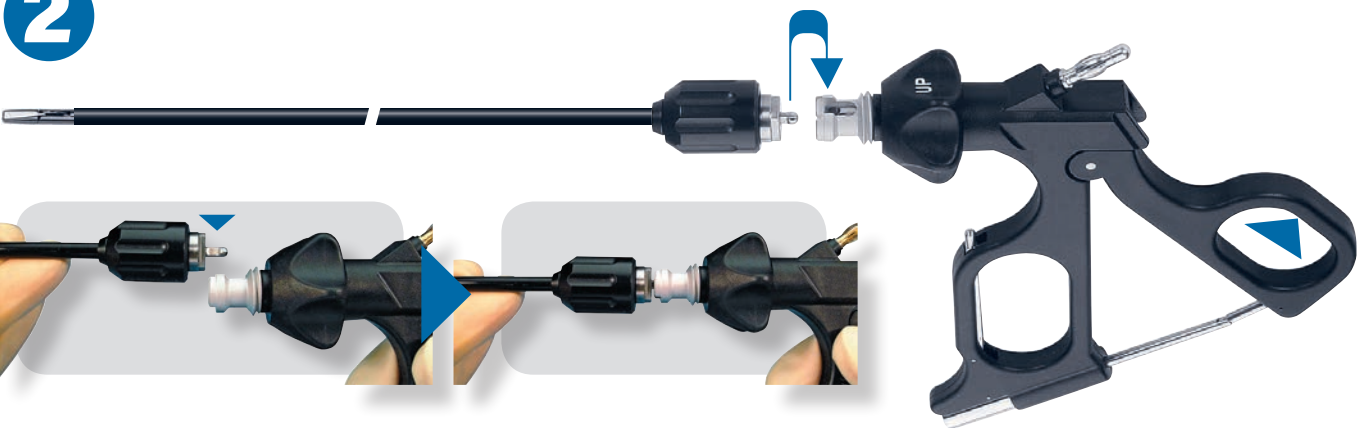

3

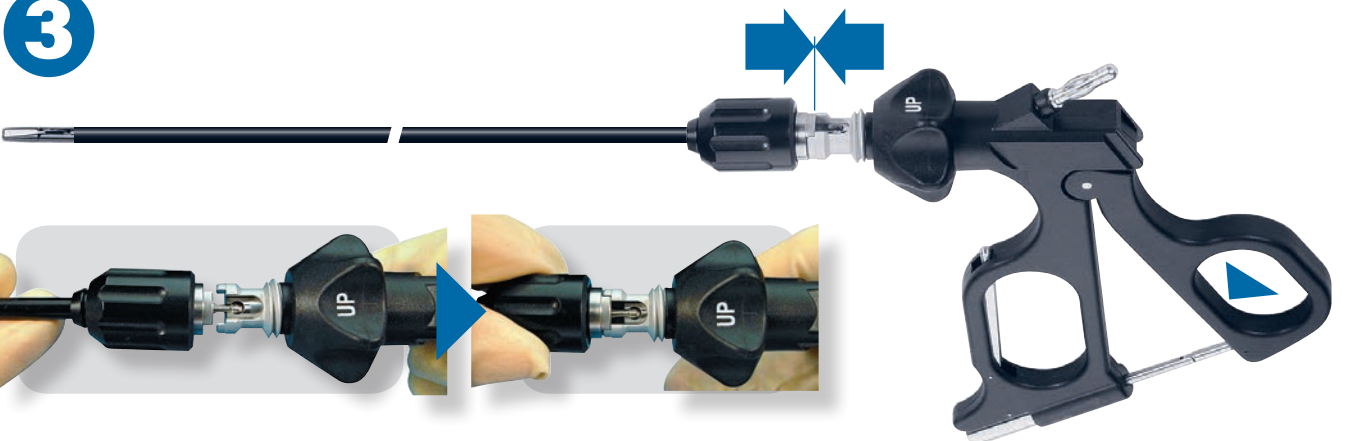

4



1



2

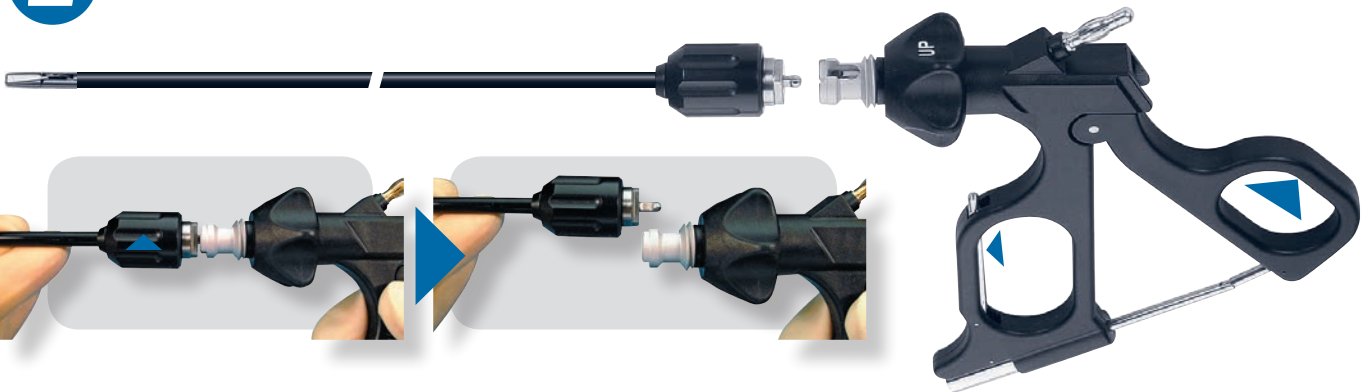

3



4







Ø 5 mm



Tube Shaft, insulated shaft length: **330 mm**
 without LUER Lock with LUER Lock
R030 - 050330 - 000 R030 - 050330 - 000 L

Tube Shaft, insulated shaft length: **360 mm**
 without LUER Lock with LUER Lock
R030 - 050360 - 000 R030 - 050360 - 000 L





Tube Shaft, insulated shaft length: **450 mm**
 without LUER Lock with LUER Lock
R030 - 050450 - 000 R030 - 050450 - 000 L



Ø 10 mm



Tube Shaft, insulated shaft length: **330 mm**
 cylindrical reduce to Ø 5 mm
R030 - 100330 - 000 R030 - 100330 - 000 5

Tube Shaft, insulated, for adipose patients shaft length: **360 mm**
 cylindrical reduce to Ø 5 mm
R030 - 100360 - 000 R030 - 100360 - 000 5

Tube Shaft, insulated, for adipose patients shaft length: **450 mm**
 cylindrical reduce to Ø 5 mm
R030 - 100450 - 000 R030 - 100450 - 000 5

Carbon Handles

more details at the beginning of the chapter

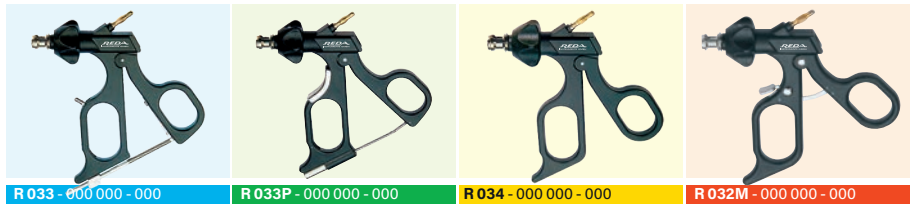

Ø 5 mm

R 033 - 000 000 - 000

R 033P - 000 000 - 000

R 034 - 000 000 - 000

R 032M - 000 000 - 000



↔ 17,5 mm

Universal grasping forceps, double action jaws

Working length | Working insert alone | Complete instrument

330 mm	R030-050330-210	R033-050330-210	R033P-050330-210	R034-050330-210	R032M-050330-210
360 mm	R030-050360-210	R033-050360-210	R033P-050360-210	R034-050360-210	R032M-050360-210
450 mm	R030-050450-210	R033-050450-210	R033P-050450-210	R034-050450-210	R032M-050450-210



↔ 17,5 mm

MARYLAND grasping and dissecting forceps, double action jaws

Working length | Working insert alone | Complete instrument

330 mm	R030-050330-212	R033-050330-212	R033P-050330-212	R034-050330-212	R032M-050330-212
360 mm	R030-050360-212	R033-050360-212	R033P-050360-212	R034-050360-212	R032M-050360-212
450 mm	R030-050450-212	R033-050450-212	R033P-050450-212	R034-050450-212	R032M-050450-212



↔ 16 mm

Dissecting forceps, fenestrated, double action jaws

Working length | Working insert alone | Complete instrument

330 mm	R030-050330-213	R033-050330-213	R033P-050330-213	R034-050330-213	R032M-050330-213
360 mm	R030-050360-213	R033-050360-213	R033P-050360-213	R034-050360-213	R032M-050360-213
450 mm	R030-050450-213	R033-050450-213	R033P-050450-213	R034-050450-213	R032M-050450-213



↔ 15 mm

Dissecting forceps, fenestrated, oval, double action jaws

Working length | Working insert alone | Complete instrument

330 mm	R030-050330-214	R033-050330-214	R033P-050330-214	R034-050330-214	R032M-050330-214
360 mm	R030-050360-214	R033-050360-214	R033P-050360-214	R034-050360-214	R032M-050360-214
450 mm	R030-050450-214	R033-050450-214	R033P-050450-214	R034-050450-214	R032M-050450-214

Carbon Handles

more details at the beginning of the chapter

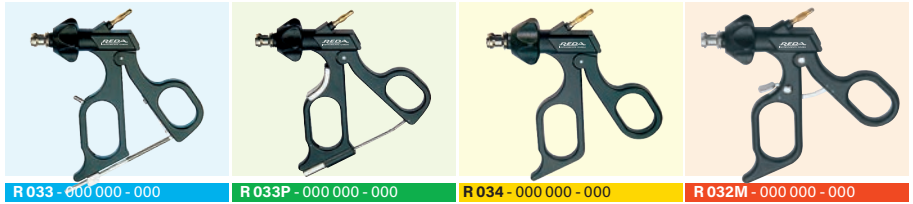

Ø 5 mm



Duck Bill-forceps, fenestrated, single action jaws

↔ 15 mm

Working length	Working insert alone	Complete instrument			
330 mm	R030-050330-215	R033-050330-215	R033P-050330-215	R034-050330-215	R032M-050330-215
360 mm	R030-050360-215	R033-050360-215	R033P-050360-215	R034-050360-215	R032M-050360-215
450 mm	R030-050450-215	R033-050450-215	R033P-050450-215	R034-050450-215	R032M-050450-215



Dissecting grasping forceps, slim, fenestrated, double action jaws

↔ 10 mm

Working length	Working insert alone	Complete instrument			
330 mm	R030-050330-216	R033-050330-216	R033P-050330-216	R034-050330-216	R032M-050330-216
360 mm	R030-050360-216	R033-050360-216	R033P-050360-216	R034-050360-216	R032M-050360-216
450 mm	R030-050450-216	R033-050450-216	R033P-050450-216	R034-050450-216	R032M-050450-216



Grasping forceps with 2 x 4 teeth cobra, double action jaws

↔ 13 mm

Working length	Working insert alone	Complete instrument			
330 mm	R030-050330-218	R033-050330-218	R033P-050330-218	R034-050330-218	R032M-050330-218
360 mm	R030-050360-218	R033-050360-218	R033P-050360-218	R034-050360-218	R032M-050450-218
450 mm	R030-050450-218	R033-050450-218	R033P-050450-218	R034-050450-218	R032M-050450-218



Grasping forceps with 2 x 4 teeth cobra, single action jaws

↔ 11 mm

Working length	Working insert alone	Complete instrument			
330 mm	R030-050330-219	R033-050330-219	R033P-050330-219	R034-050330-219	R032M-050330-219
360 mm	R030-050360-219	R033-050360-219	R033P-050360-219	R034-050360-219	R032M-050360-219
450 mm	R030-050450-219	R033-050450-219	R033P-050450-219	R034-050450-219	R032M-050450-219

Carbon Handles

more details at the beginning of the chapter

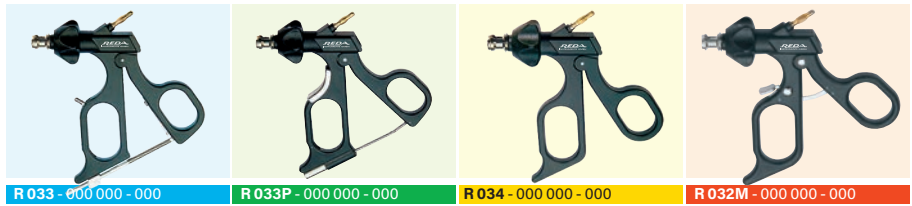

Ø 5 mm

R 033 - 000 000 - 000

R 033P - 000 000 - 000

R 034 - 000 000 - 000

R 032M - 000 000 - 000



Grasping forceps with reservoir, tip blunt, double action jaws

↔ 13,5 mm

Working length	Working insert alone	Complete instrument			
330 mm	R030-050330-220	R033-050330-220	R033P-050330-220	R034-050330-220	R032M-050330-220
360 mm	R030-050360-220	R033-050360-220	R033P-050360-220	R034-050360-220	R032M-050360-220
450 mm	R030-050450-220	R033-050450-220	R033P-050450-220	R034-050450-220	R032M-050450-220



Grasping forceps with reservoir, tip conical, double action jaws

↔ 13,5 mm

Working length	Working insert alone	Complete instrument			
330 mm	R030-050330-222	R033-050330-222	R033P-050330-222	R034-050330-222	R032M-050330-222
360 mm	R030-050360-222	R033-050360-222	R033P-050360-222	R034-050360-222	R032M-050360-222
450 mm	R030-050450-222	R033-050450-222	R033P-050450-222	R034-050450-222	R032M-050450-222



Delphin grasping forceps, double action jaws

↔ 17,5 mm

Working length	Working insert alone	Complete instrument			
330 mm	R030-050330-224	R033-050330-224	R033P-050330-224	R034-050330-224	R032M-050330-224
360 mm	R030-050360-224	R033-050360-224	R033P-050360-224	R034-050360-224	R032M-050360-224
450 mm	R030-050450-224	R033-050450-224	R033P-050450-224	R034-050450-224	R032M-050450-224



Delphin grasping forceps with reservoir, long, double action jaws

↔ 26 mm

Working length	Working insert alone	Complete instrument			
330 mm	R030-050330-225	R033-050330-225	R033P-050330-225	R034-050330-225	R032M-050330-225
360 mm	R030-050360-225	R033-050360-225	R033P-050360-225	R034-050360-225	R032M-050360-225
450 mm	R030-050450-225	R033-050450-225	R033P-050450-225	R034-050450-225	R032M-050450-225

Carbon Handles

more details at the beginning of the chapter

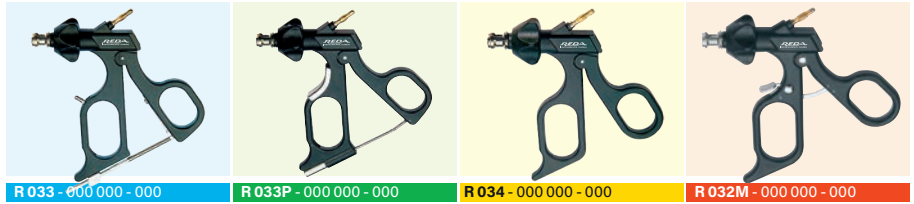

R 033 - 000 000 - 000

R 033P - 000 000 - 000

R 034 - 000 000 - 000

R 032M - 000 000 - 000

Ø 5 mm



Fallopian tube grasping forceps, double action jaws

↔ 15 mm

Working length | Working insert alone | Complete instrument

330 mm	R030-050330-226	R033-050330-226	R033P-050330-226	R034-050330-226	R032M-050330-226
360 mm	R030-050360-226	R033-050360-226	R033P-050360-226	R034-050360-226	R032M-050360-226
450 mm	R030-050450-226	R033-050450-226	R033P-050450-226	R034-050450-226	R032M-050450-226



Grasping forceps crosswise teeth, jaw length 14 mm, conical, double action jaws

↔ 14 mm

Working length | Working insert alone | Complete instrument

330 mm	R030-050330-228	R033-050330-228	R033P-050330-228	R034-050330-228	R032M-050330-228
360 mm	R030-050360-228	R033-050360-228	R033P-050360-228	R034-050360-228	R032M-050360-228
450 mm	R030-050450-228	R033-050450-228	R033P-050450-228	R034-050450-228	R032M-050450-228



Grasping forceps crosswise teeth, jaw length 18 mm, conical, double action jaws

↔ 18 mm

Working length | Working insert alone | Complete instrument

330 mm	R030-050330-230	R033-050330-230	R033P-050330-230	R034-050330-230	R032M-050330-230
360 mm	R030-050360-230	R033-050360-230	R033P-050360-230	R034-050360-230	R032M-050360-230
450 mm	R030-050450-230	R033-050450-230	R033P-050450-230	R034-050450-230	R032M-050450-230



MAHNES grasping forceps, distal fine crosswise teeth, single action jaws

↔ 11 mm

Working length | Working insert alone | Complete instrument

330 mm	R030-050330-231	R033-050330-231	R033P-050330-231	R034-050330-231	R032M-050330-231
360 mm	R030-050360-231	R033-050360-231	R033P-050360-231	R034-050360-231	R032M-050360-231
450 mm	R030-050450-231	R033-050450-231	R033P-050450-231	R034-050450-231	R032M-050450-231

Carbon Handles

more details at the beginning of the chapter

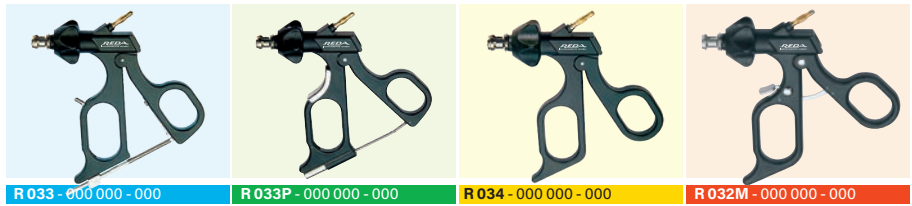

Ø 5 mm

R 033 - 000 000 - 000

R 033P - 000 000 - 000

R 034 - 000 000 - 000

R 032M - 000 000 - 000



MAHNES grasping forceps, distal fine crosswise teeth, double action jaws

↔ 11,5 mm

Working length	Working insert alone	Complete instrument			
330 mm	R030-050330-232	R033-050330-232	R033P-050330-232	R034-050330-232	R032M-050330-232
360 mm	R030-050360-232	R033-050360-232	R033P-050360-232	R034-050360-232	R032M-050360-232
450 mm	R030-050450-232	R033-050450-232	R033P-050450-232	R034-050450-232	R032M-050450-232



Grasping forceps, double action jaws

↔ 20 mm

Working length	Working insert alone	Complete instrument			
330 mm	R030-050330-234	R033-050330-234	R033P-050330-234	R034-050330-234	R032M-050330-234
360 mm	R030-050360-234	R033-050360-234	R033P-050360-234	R034-050360-234	R032M-050360-234
450 mm	R030-050450-234	R033-050450-234	R033P-050450-234	R034-050450-234	R032M-050450-234



REDDICK-OLSEN grasping forceps, strong, double action jaws

↔ 9,5 mm

Working length	Working insert alone	Complete instrument			
330 mm	R030-050330-236	R033-050330-236	R033P-050330-236	R034-050330-236	R032M-050330-236
360 mm	R030-050360-236	R033-050360-236	R033P-050360-236	R034-050360-236	R032M-050360-236
450 mm	R030-050450-236	R033-050450-236	R033P-050450-236	R034-050450-236	R032M-050450-236



Grasping forceps, distal with a atraumatic row of teeth, double action jaws

↔ 29 mm

Working length	Working insert alone	Complete instrument			
330 mm	R030-050330-238	R033-050330-238	R033P-050330-238	R034-050330-238	R032M-050330-238
360 mm	R030-050360-238	R033-050360-238	R033P-050360-238	R034-050360-238	R032M-050360-238
450 mm	R030-050450-238	R033-050450-238	R033P-050450-238	R034-050450-238	R032M-050450-238

Carbon Handles

more details at the beginning of the chapter

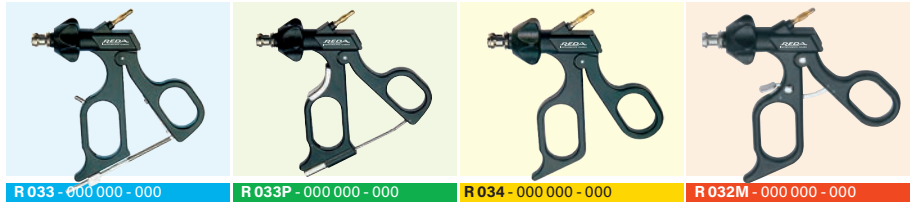

R 033 - 000 000 - 000

R 033P - 000 000 - 000

R 034 - 000 000 - 000

R 032M - 000 000 - 000

Ø 5 mm



↔ 13,5 mm

MAHNES grasping forceps 1 x 2 teeth, double action jaws

Working length | Working insert alone | Complete instrument

330 mm	R030-050330-240	R033-050330-240	R033P-050330-240	R034-050330-240	R032M-050330-240
360 mm	R030-050360-240	R033-050360-240	R033P-050360-240	R034-050360-240	R032M-050360-240
450 mm	R030-050450-240	R033-050450-240	R033P-050450-240	R034-050450-240	R032M-050450-240



↔ 13,5 mm

Grasping forceps with mouseteeth, single action jaws

Working length | Working insert alone | Complete instrument

330 mm	R030-050330-241	R033-050330-241	R033P-050330-241	R034-050330-241	R032M-050330-241
360 mm	R030-050360-241	R033-050360-241	R033P-050360-241	R034-050360-241	R032M-050360-241
450 mm	R030-050450-241	R033-050450-241	R033P-050450-241	R034-050450-241	R032M-050450-241



↔ 22 mm

Claw grasping forceps, 3 x 2 teeth, single action jaws

Working length | Working insert alone | Complete instrument

330 mm	R030-050330-242	R033-050330-242	R033P-050330-242	R034-050330-242	R032M-050330-242
360 mm	R030-050360-242	R033-050360-242	R033P-050360-242	R034-050360-242	R032M-050360-242
450 mm	R030-050450-242	R033-050450-242	R033P-050450-242	R034-050450-242	R032M-050450-242

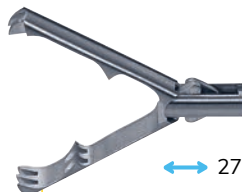

↔ 27 mm

„AGRESSIV“, Claw Grasping forceps, double action jaws

Working length | Working insert alone | Complete instrument

330 mm	R030-050330-243	R033-050330-243	R033P-050330-243	R034-050330-243	R032M-050330-243
360 mm	R030-050360-243	R033-050360-243	R033P-050360-243	R034-050360-243	R032M-050360-243
450 mm	R030-050450-243	R033-050450-243	R033P-050450-243	R034-050450-243	R032M-050450-243

Carbon Handles

more details at the beginning of the chapter

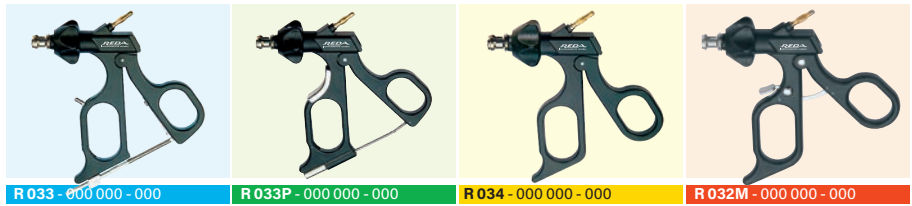

Ø 5 mm



Grasping forceps distal with DEBAKEY teeth, double action jaws

Working length	Working insert alone	Complete instrument			
330 mm	R030-050330-244	R033-050330-244	R033P-050330-244	R034-050330-244	R032M-050330-244
360 mm	R030-050360-244	R033-050360-244	R033P-050360-244	R034-050360-244	R032M-050360-244
450 mm	R030-050450-244	R033-050450-244	R033P-050450-244	R034-050450-244	R032M-050450-244



Extracting forceps with retrograd teeth, double action jaws

Working length	Working insert alone	Complete instrument			
330 mm	R030-050330-246	R033-050330-246	R033P-050330-246	R034-050330-246	R032M-050330-246
360 mm	R030-050360-246	R033-050360-246	R033P-050360-246	R034-050360-246	R032M-050360-246
450 mm	R030-050450-246	R033-050450-246	R033P-050450-246	R034-050450-246	R032M-050450-246

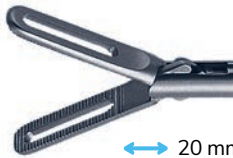

DORSEY (JOHANN) intestinal grasping forceps, jaw length 20 mm, double action jaws

Working length	Working insert alone	Complete instrument			
330 mm	R030-050330-248	R033-050330-248	R033P-050330-248	R034-050330-248	R032M-050330-248
360 mm	R030-050360-248	R033-050360-248	R033P-050360-248	R034-050360-248	R032M-050360-248
450 mm	R030-050450-248	R033-050450-248	R033P-050450-248	R034-050450-248	R032M-050450-248



DORSEY (JOHANN) intestinal grasping forceps, jaw length 20 mm, single action jaws

Working length	Working insert alone	Complete instrument			
330 mm	R030-050330-249	R033-050330-249	R033P-050330-249	R034-050330-249	R032M-050330-249
360 mm	R030-050360-249	R033-050360-249	R033P-050360-249	R034-050360-249	R032M-050360-249
450 mm	R030-050450-249	R033-050450-249	R033P-050450-249	R034-050450-249	R032M-050450-249

Carbon Handles

more details at the beginning of the chapter

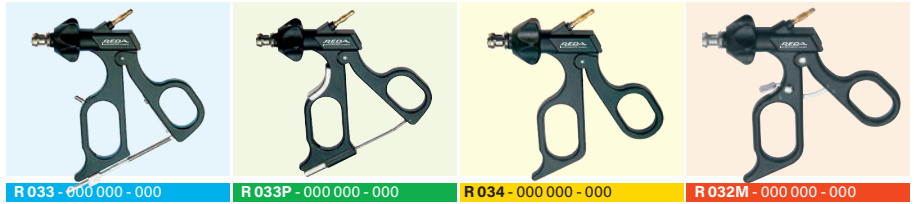

R 033 - 000 000 - 000

R 033P - 000 000 - 000

R 034 - 000 000 - 000

R 032M - 000 000 - 000

Ø 5 mm



↔ 21,5 mm

DAVIS & GEEK grasping forceps with reservoir, single action jaws

Working length	Working insert alone	Complete instrument			
330 mm	R030-050330-250	R033-050330-250	R033P-050330-250	R034-050330-250	R032M-050330-250
360 mm	R030-050360-250	R033-050360-250	R033P-050360-250	R034-050360-250	R032M-050360-250
450 mm	R030-050450-250	R033-050450-250	R033P-050450-250	R034-050450-250	R032M-050450-250

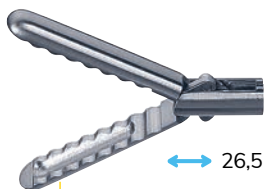

↔ 26,5 mm

DAVIS & GEEK grasping forceps with reservoir, double action jaws

Working length	Working insert alone	Complete instrument			
330 mm	R030-050330-251	R033-050330-251	R033P-050330-251	R034-050330-251	R032M-050330-251
360 mm	R030-050360-251	R033-050360-251	R033P-050360-251	R034-050360-251	R032M-050360-251
450 mm	R030-050450-251	R033-050450-251	R033P-050450-251	R034-050450-251	R032M-050450-251

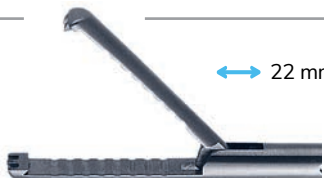

↔ 22 mm

DAVIS & GEEK grasping forceps with 3 x 2 teeth, single action jaws

Working length	Working insert alone	Complete instrument			
330 mm	R030-050330-252	R033-050330-252	R033P-050330-252	R034-050330-252	R032M-050330-252
360 mm	R030-050360-252	R033-050360-252	R033P-050360-252	R034-050360-252	R032M-050360-252
450 mm	R030-050450-252	R033-050450-252	R033P-050450-252	R034-050450-252	R032M-050450-252



↔ 20 mm

MIXTER grasping forceps 90°, double action jaws

Working length	Working insert alone	Complete instrument			
330 mm	R030-050330-258	R033-050330-258	R033P-050330-258	R034-050330-258	R032M-050330-258
360 mm	R030-050360-258	R033-050360-258	R033P-050360-258	R034-050360-258	R032M-050360-258
450 mm	R030-050450-258	R033-050450-258	R033P-050450-258	R034-050450-258	R032M-050450-258

Carbon Handles

more details at the beginning of the chapter

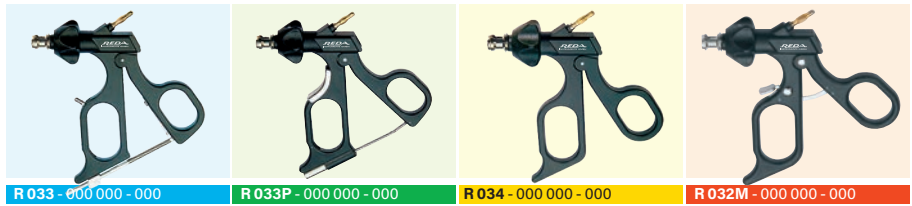

Ø 5 mm

R 033 - 000 000 - 000

R 033P - 000 000 - 000

R 034 - 000 000 - 000

R 032M - 000 000 - 000

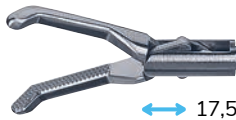

MIXTER grasping forceps 45°, double action jaws

↔ 17,5 mm

Working length | Working insert alone | Complete instrument

330 mm	R030-050330-259	R033-050330-259	R033P-050330-259	R034-050330-259	R032M-050330-259
360 mm	R030-050360-259	R033-050360-259	R033P-050360-259	R034-050360-259	R032M-050360-259
450 mm	R030-050450-259	R033-050450-259	R033P-050450-259	R034-050450-259	R032M-050450-259

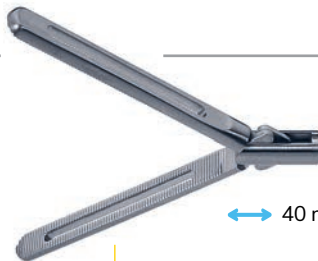

DORSEY intestinal grasping forceps, jaw length 40 mm, double action jaws

↔ 40 mm

Working length | Working insert alone | Complete instrument

330 mm	R030-050330-262	R033-050330-262	R033P-050330-262	R034-050330-262	R032M-050330-262
360 mm	R030-050360-262	R033-050360-262	R033P-050360-262	R034-050360-262	R032M-050360-262
450 mm	R030-050450-262	R033-050450-262	R033P-050450-262	R034-050450-262	R032M-050450-262

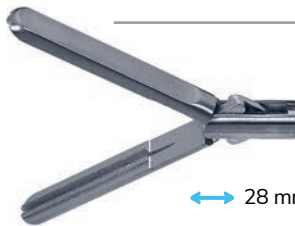

DEBAKEY clamp, jaw length 30 mm, double action jaws

↔ 28 mm

Working length | Working insert alone | Complete instrument

330 mm	R030-050330-264	R033-050330-264	R033P-050330-264	R034-050330-264	R032M-050330-264
360 mm	R030-050360-264	R033-050360-264	R033P-050360-264	R034-050360-264	R032M-050360-264
450 mm	R030-050450-264	R033-050450-264	R033P-050450-264	R034-050450-264	R032M-050450-264



KELLY Grasping forceps, double action jaws

↔ 11 mm

Working length | Working insert alone | Complete instrument

330 mm	R030-050330-266	R033-050330-266	R033P-050330-266	R034-050330-266	R032M-050330-266
360 mm	R030-050360-266	R033-050360-266	R033P-050360-266	R034-050360-266	R032M-050360-266
450 mm	R030-050450-266	R033-050450-266	R033P-050450-266	R034-050450-266	R032M-050450-266

Carbon Handles

more details at the beginning of the chapter

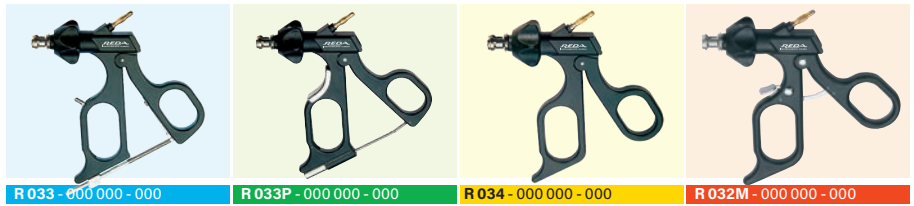

R 033 - 000 000 - 000

R 033P - 000 000 - 000

R 034 - 000 000 - 000

R 032M - 000 000 - 000

Ø 5 mm

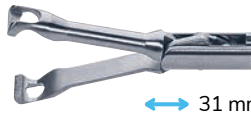

BABCOCK clamp, double action jaws

↔ 31 mm

Working length	Working insert alone	Complete instrument			
330 mm	R030-050330-270	R033-050330-270	R033P-050330-270	R034-050330-270	R032M-050330-270
360 mm	R030-050360-270	R033-050360-270	R033P-050360-270	R034-050360-270	R032M-050360-270
450 mm	R030-050450-270	R033-050450-270	R033P-050450-270	R034-050450-270	R032M-050450-270



Grasping Forceps, straight, cross-serrated, jaw length 18 mm, single action jaws

↔ 18 mm

		Working length	Working insert alone	Complete instrument	
330 mm	R030-050330-272	R033-050330-272	R033P-050330-272	R034-050330-272	R032M-050330-272
360 mm	R030-050360-272	R033-050360-272	R033P-050360-272	R034-050360-272	R032M-050360-272
450 mm	R030-050450-272	R033-050450-272	R033P-050450-272	R034-050450-272	R032M-050450-272

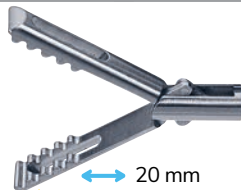

Grasping forceps „WAVE“, fenestrated, double action jaws

↔ 20 mm

Working length	Working insert alone	Complete instrument			
330 mm	R030-050330-274	R033-050330-274	R033P-050330-274	R034-050330-274	R032M-050330-274
360 mm	R030-050360-274	R033-050360-274	R033P-050360-274	R034-050360-274	R032M-050360-274
450 mm	R030-050450-274	R033-050450-274	R033P-050450-274	R034-050450-274	R032M-050450-274

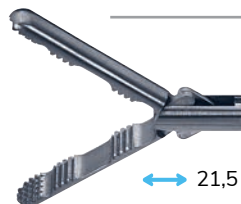

Grasping forceps „MAXIGRIP“, double action jaws

↔ 21,5 mm

Working length	Working insert alone	Complete instrument			
330 mm	R030-050330-276	R033-050330-276	R033P-050330-276	R034-050330-276	R032M-050330-276
360 mm	R030-050360-276	R033-050360-276	R033P-050360-276	R034-050360-276	R032M-050360-276
450 mm	R030-050450-276	R033-050450-276	R033P-050450-276	R034-050450-276	R032M-050450-276

Carbon Handles

more details at the beginning of the chapter

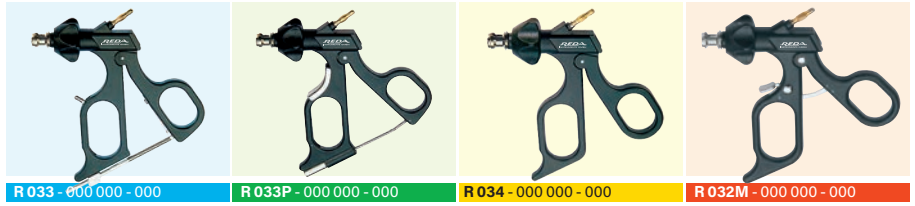

Ø 5 mm

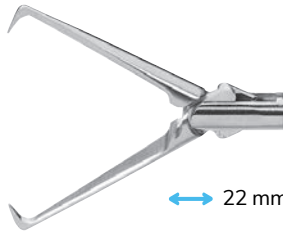

Tenaculum forceps, double action jaws

↔ 22 mm

Working length	Working insert alone	Complete instrument			
330 mm	R030-050330-284	R033-050330-284	R033P-050330-284	R034-050330-284	R032M-050330-284
360 mm	R030-050360-284	R033-050360-284	R033P-050360-284	R034-050360-284	R032M-050360-284
450 mm	R030-050450-284	R033-050450-284	R033P-050450-284	R034-050450-284	R032M-050450-284

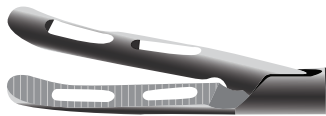

CROCE-OLMI grasping forceps, atrumatic, fenestrated, curved

↔ 22 mm

Working length	Working insert alone	Complete instrument			
330 mm	R030-050330-217	R033-050330-217	R033P-050330-217	R034-050330-217	R032M-050330-217
360 mm	R030-050360-217	R033-050360-217	R033P-050360-217	R034-050360-217	R032M-050360-217
450 mm	R030-050450-217	R033-050450-217	R033P-050450-217	R034-050450-217	R032M-050450-217

Carbon Handles

more details at the beginning of the chapter

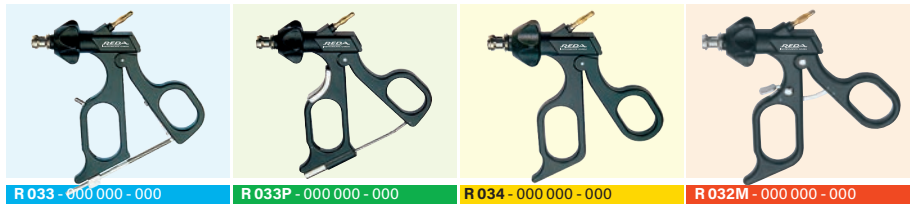

R 033 - 000 000 - 000

R 033P - 000 000 - 000

R 034 - 000 000 - 000

R 032M - 000 000 - 000

Ø 10 mm

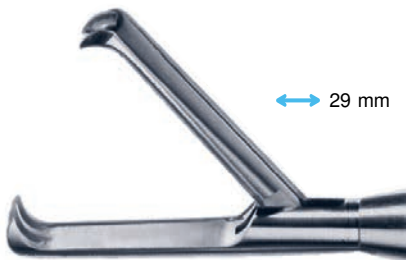

↔ 29 mm

Claw grasping forceps, 3 x 2 teeth, single action jaws

Working length	Working insert alone	Complete instrument			
330 mm	R030-100330-610	R033-100330-610	R033P-100330-610	R034-100330-610	R032M-100330-610
360 mm	R030-100360-610	R033-100360-610	R033P-100360-610	R034-100360-610	R032M-100360-610
450 mm	R030-100450-610	R033-100450-610	R033P-100450-610	R034-100450-610	R032M-100450-610



↔ 24 mm

MARYLAND grasping and dissecting forceps, double action jaws

Working length	Working insert alone	Complete instrument			
330 mm	R030-100330-612	R033-100330-612	R033P-100330-612	R034-100330-612	R032M-100330-612
360 mm	R030-100360-612	R033-100360-612	R033P-100360-612	R034-100360-612	R032M-100360-612
450 mm	R030-100450-612	R033-100450-612	R033P-100450-612	R034-100450-612	R032M-100450-612



↔ 27,5 mm

Grasping forceps distal with DEBAKEY teeth, double action jaws

Working length	Working insert alone	Complete instrument			
330 mm	R030-100330-614	R033-100330-614	R033P-100330-614	R034-100330-614	R032M-100330-614
360 mm	R030-100360-614	R033-100360-614	R033P-100360-614	R034-100360-614	R032M-100360-614
450 mm	R030-100450-614	R033-100450-614	R033P-100450-614	R034-100450-614	R032M-100450-614

Carbon Handles

more details at the beginning of the chapter

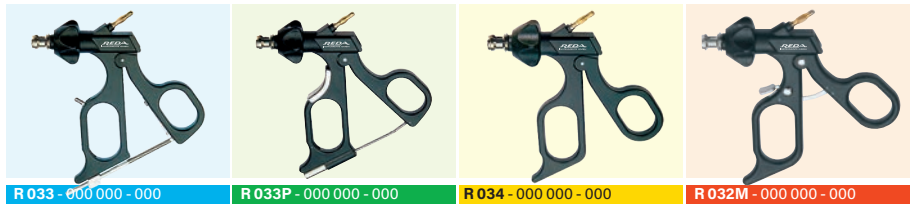

Ø 10 mm



BABCOCK grasping forceps, strong, double action jaws

↔ 27mm

Working length	Working insert alone	Complete instrument			
330 mm	R030-100330-616	R033-100330-616	R033P-100330-616	R034-100330-616	R032M-100330-616
360 mm	R030-100360-616	R033-100360-616	R033P-100360-616	R034-100360-616	R032M-100360-616
450 mm	R030-100450-616	R033-100450-616	R033P-100450-616	R034-100450-616	R032M-100450-616

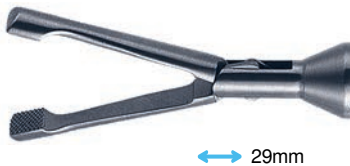

Grasping forceps, cross-serrated teeth, double action jaws

↔ 29mm

Working length	Working insert alone	Complete instrument			
330 mm	R030-100330-642	R033-100330-642	R033P-100330-642	R034-100330-642	R032M-100330-642
360 mm	R030-100360-642	R033-100360-642	R033P-100360-642	R034-100360-642	R032M-100360-642
450 mm	R030-100450-642	R033-100450-642	R033P-100450-642	R034-100450-642	R032M-100450-642

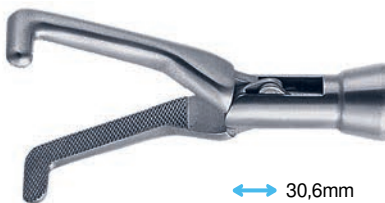

MIXTER grasping forceps, double action jaws

↔ 30,6mm

Working length	Working insert alone	Complete instrument			
330 mm	R030-100330-646	R033-100330-646	R033P-100330-646	R034-100330-646	R032M-100330-646
360 mm	R030-100360-646	R033-100360-646	R033P-100360-646	R034-100360-646	R032M-100360-646
450 mm	R030-100450-646	R033-100450-646	R033P-100450-646	R034-100450-646	R032M-100450-646



DORSEY intestinal grasping forceps, double action jaws

↔ 27mm

Working length	Working insert alone	Complete instrument			
330 mm	R030-100330-648	R033-100330-648	R033P-100330-648	R034-100330-648	R032M-100330-648
360 mm	R030-100360-648	R033-100360-648	R033P-100360-648	R034-100360-648	R032M-100360-648
450 mm	R030-100450-648	R033-100450-648	R033P-100450-648	R034-100450-648	R032M-100450-648

Carbon Handles

more details at the beginning of the chapter

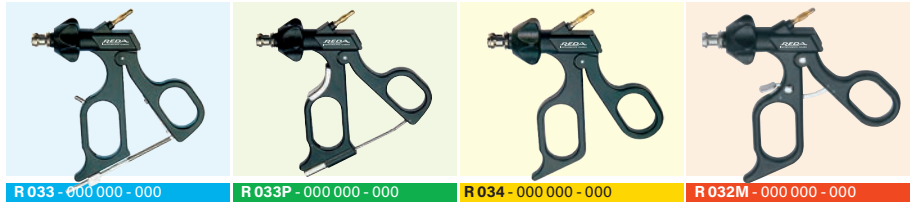

Ø 10 mm



↔ 30mm

KOCHER clamp, jaw length 30 mm, double action jaws

Working length	Working insert alone	Complete instrument			
330 mm	R030-100330-622	R033-100330-622	R033P-100330-622	R034-100330-622	R032M-100330-622
360 mm	R030-100360-622	R033-100360-622	R033P-100360-622	R034-100360-622	R032M-100360-622
jaw length 40 mm					
330 mm	R030-100330-623	R033-100330-623	R033P-100330-623	R034-100330-623	R032M-100330-623
360 mm	R030-100360-623	R033-100360-623	R033P-100360-623	R034-100360-623	R032M-100360-623
jaw length 50 mm					
330 mm	R030-100330-624	R033-100330-624	R033P-100330-624	R034-100330-624	R032M-100330-624
360 mm	R030-100360-624	R033-100360-624	R033P-100360-624	R034-100360-624	R032M-100360-624



↔ 30mm

DEBAKEY clamp, double teeth, jaw length 30 mm, double action jaws

Working length	Working insert alone	Complete instrument			
330 mm	R030-100330-631	R033-100330-631	R033P-100330-631	R034-100330-631	R032M-100330-631
360 mm	R030-100360-631	R033-100360-631	R033P-100360-631	R034-100360-631	R032M-100360-631
jaw length 40 mm					
330 mm	R030-100330-632	R033-100330-632	R033P-100330-632	R034-100330-632	R032M-100330-632
360 mm	R030-100360-632	R033-100360-632	R033P-100360-632	R034-100360-632	R032M-100360-632
jaw length 50 mm					
330 mm	R030-100330-633	R033-100330-633	R033P-100330-633	R034-100330-633	R032M-100330-633
360 mm	R030-100360-633	R033-100360-633	R033P-100360-633	R034-100360-633	R032M-100360-633

Carbon Handles

more details at the beginning of the chapter

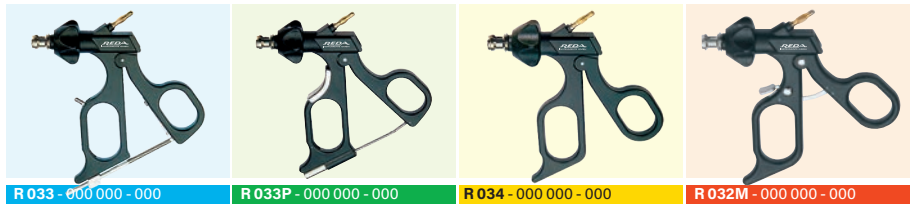

R 033 - 000 000 - 000

R 033P - 000 000 - 000

R 034 - 000 000 - 000

R 032M - 000 000 - 000

Ø 10 mm



BABCOCK grasping forceps fine, double action jaws

Working length	Working insert alone	Complete instrument			
330 mm	R030-100330-618	R033-100330-618	R033P-100330-618	R034-100330-618	R032M-100330-618
360 mm	R030-100360-618	R033-100360-618	R033P-100360-618	R034-100360-618	R032M-100360-618



COLLIN clamp, double action jaws

Working length	Working insert alone	Complete instrument			
330 mm	R030-100330-620	R033-100330-620	R033P-100330-620	R034-100330-620	R032M-100330-620
360 mm	R030-100360-620	R033-100360-620	R033P-100360-620	R034-100360-620	R032M-100360-620

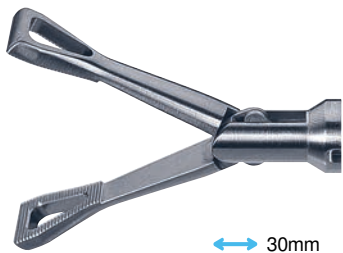

PENNINGTON clamp, double action jaws

Working length	Working insert alone	Complete instrument			
330 mm	R030-100330-650	R033-100330-650	R033P-100330-650	R034-100330-650	R032M-100330-650
360 mm	R030-100360-650	R033-100360-650	R033P-100360-650	R034-100360-650	R032M-100360-650

Carbon Handles

more details at the beginning of the chapter

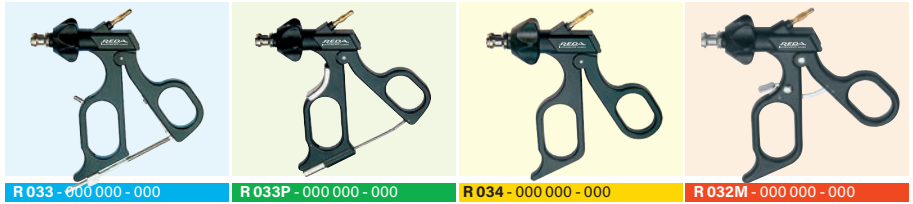

R 033 - 000 000 - 000

R 033P - 000 000 - 000

R 034 - 000 000 - 000

R 032M - 000 000 - 000

Ø 10 mm

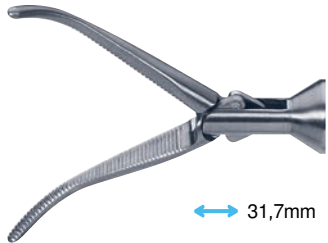

OVERHOLD clamp with fine teeth, curved, double action jaws

Working length	Working insert alone	Complete instrument			
330 mm	R030-100330-654	R033-100330-654	R033P-100330-654	R034-100330-654	R032M-100330-654
360 mm	R030-100360-654	R033-100360-654	R033P-100360-654	R034-100360-654	R032M-100360-654

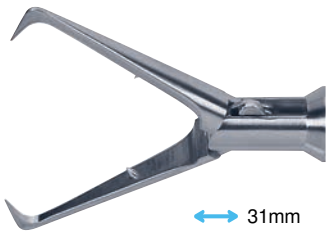

Tenaculum forceps, double action jaws

Working length	Working insert alone	Complete instrument			
330 mm	R030-100330-656	R033-100330-656	R033P-100330-656	R034-100330-656	R032M-100330-656
360 mm	R030-100360-656	R033-100360-656	R033P-100360-656	R034-100360-656	R032M-100360-656

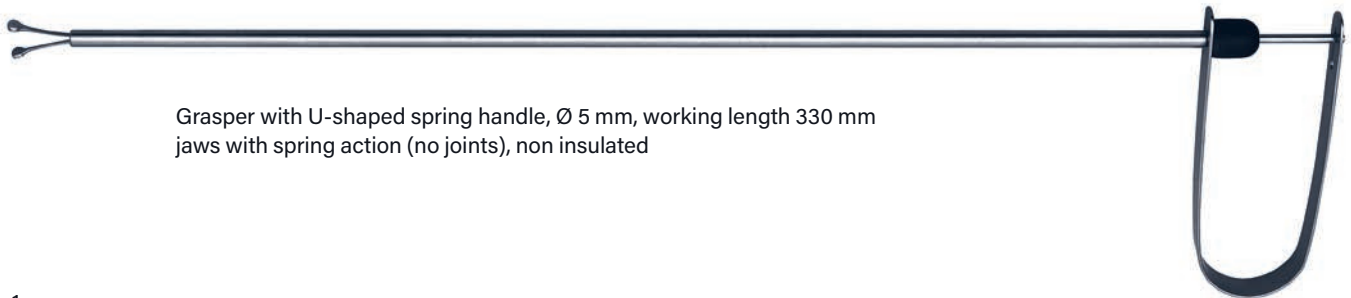

Grasper with U-shaped spring handle, Ø 5 mm, working length 330 mm
jaws with spring action (no joints), non insulated

1:1



Atraumatic grasper

R039 - 0533 - 001



Bowl grasper, square pattern jaws

R039 - 0533 - 002



Bowl grasper, T-shaped jaws

R039 - 0533 - 003



Tissue and bowel grasper, ball and socket type

R039 - 0533 - 004



Fallopian tube grasper

R039 - 0533 - 006



1 x 2 teeth grasper slim

R039 - 0533 - 007



Bowel grasper, round

R039 - 0533 - 010



Atraumatic grasper, fenestrated

R039 - 0533 - 013

1:1



Tissue grasper, U-shaped jaws

R039 - 0533 - 014



Grasper, blunt

R039 - 0533 - 015



Falopian grasper, blunt

R039 - 0533 - 016



length, diameter	
480 mm, Ø 3 mm	96000-03
480 mm, Ø 5 mm	96000-05
480 mm, Ø 7 mm	96000-07
480 mm, Ø 12 mm	96000-12

Scissors / Biopsy forceps



Ø 5 und 10 mm



Mechanical snap-action coupling !

The Ø 5 and 10 mm modular REDA laparoscopic instruments have a unique snap-action coupling which, offering the combined advantage of the speediest possible assembly and a long service life.

The union of the working insert and sleeve shaft is achieved by simply inserting the components axially into each other. A simple click and you are ready!

The groove-and-tongue principle practically rules out the possibility of the locking mechanism coming undone, as is the case with conventional screw or bayonet connections.

REDA - simplicity is so clever !



Nut stopper

An nut on the sleeve shaft of REDA modular instruments prevents bothersome slipping or even the loss of the union nut.

REDA - detail is the decisive factor !

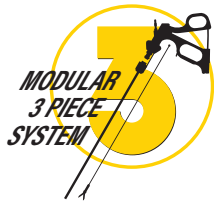

Ø 3 / 5 / 10 mm

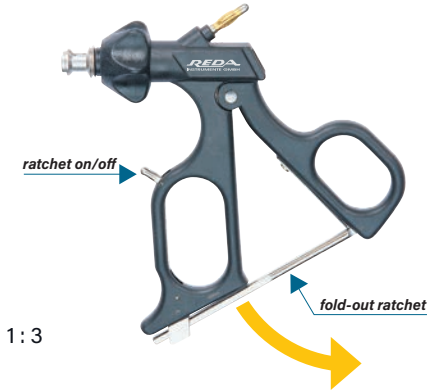

Ergonomic universal carbon handle with ratchet,
Lever for active or unactive ratchet, HF-connector Ø 4 mm male 45° lateral,
rotating head 360°, autoclavable

R033 - 000000 - 000



Ergonomic carbon handle with stepless ratchet,
ratchet by finger press resolve, HF-connector Ø 4 mm male 45° lateral,
rotating head 360°, autoclavable

R033P - 000000 - 000



Ergonomic carbon handle,
HF-connector Ø 4 mm male 45° lateral, rotating head 360°, autoclavable

R034 - 000000 - 000



Ergonomic universal carbon handle with ratchet,
Button for active or unactive ratchet, HF-connector Ø 4 mm male 45° lateral,
rotating head 360°, autoclavable

R032M - 000000 - 000

Ø 3 / 5 / 10 mm

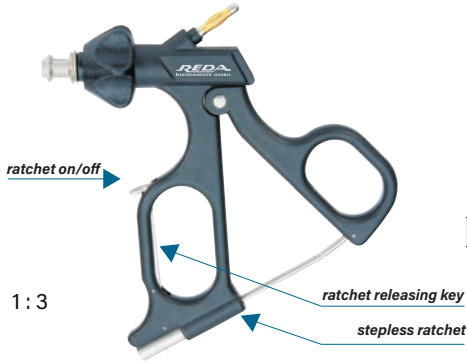

Ergonomic carbon handle with stepless ratchet,
ratchet activating / release lever, HF-connector Ø 4 mm male 45° lateral,
rotating head 360°, autoclavable

R033M - 000000 - 000

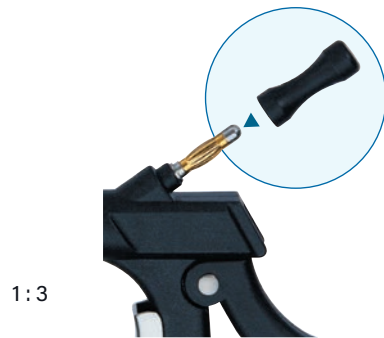

Protection cap for HF-connector Ø 4 mm

R030 - 000000



Laparoscopy -
Handles for Ø 3 / 5 / 10 mm tube shafts



Ø 3 / 5 / 10 mm



Axial handle, v-shaped type with spreading spring and ratchet

R038 - 000000 - 000

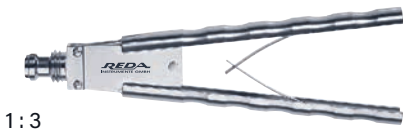

Axial handle, with spreading spring

R048 - 000000 - 000



Axial handle with rings and ratchet

R037 - 000000 - 000



Axial ring handle

R047 - 000000 - 000



Axial handle, v-shaped angled, type with spreading spring and ratchet

R039 - 000000 - 000



Axial handle, angled, with spreading spring

R040 - 000000 - 000

1

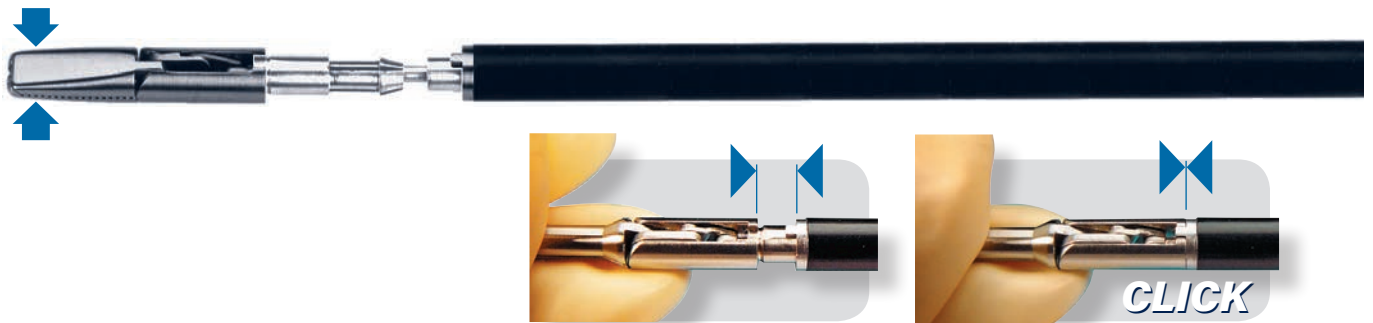

2

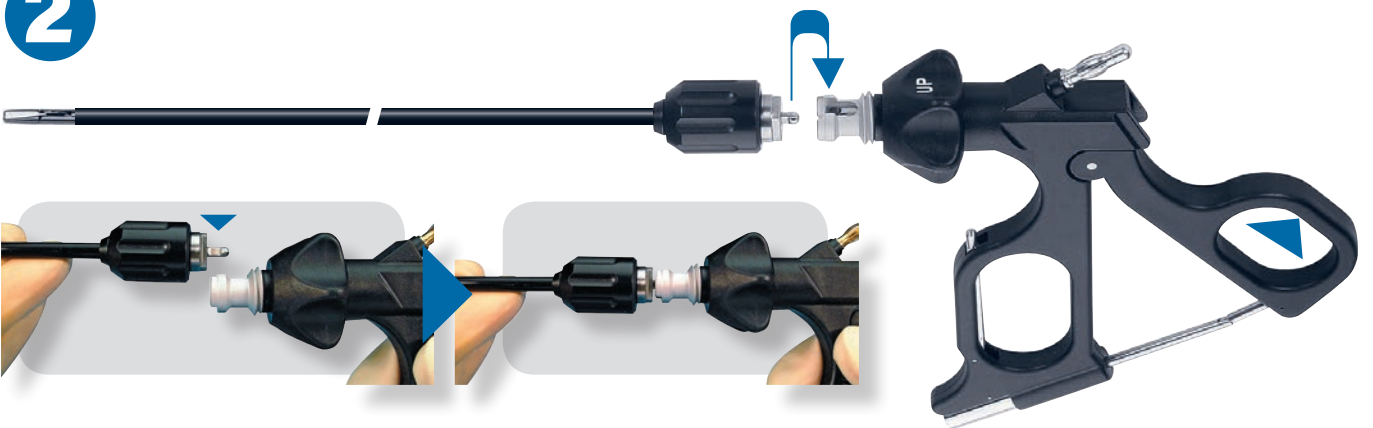

3

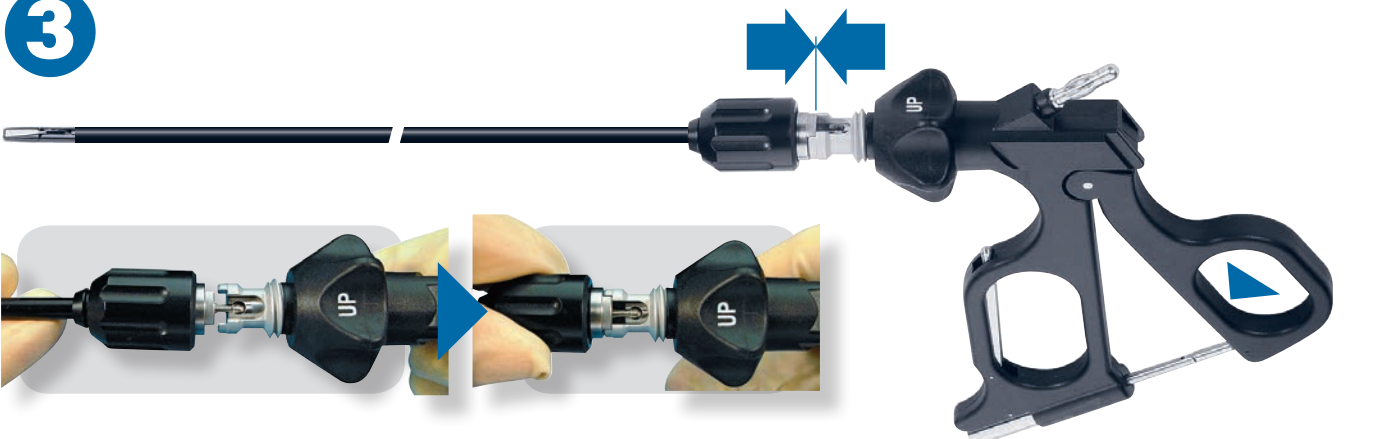

4



1



2

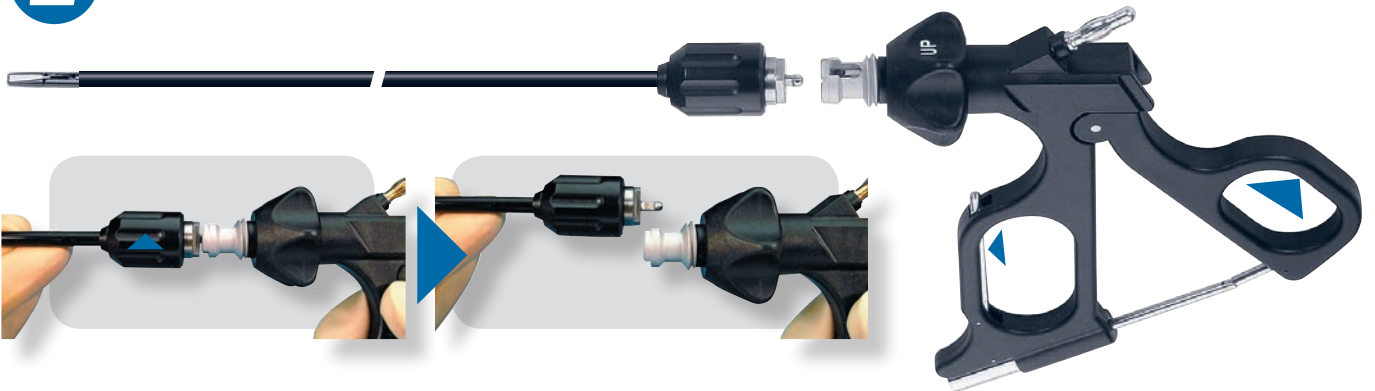

3

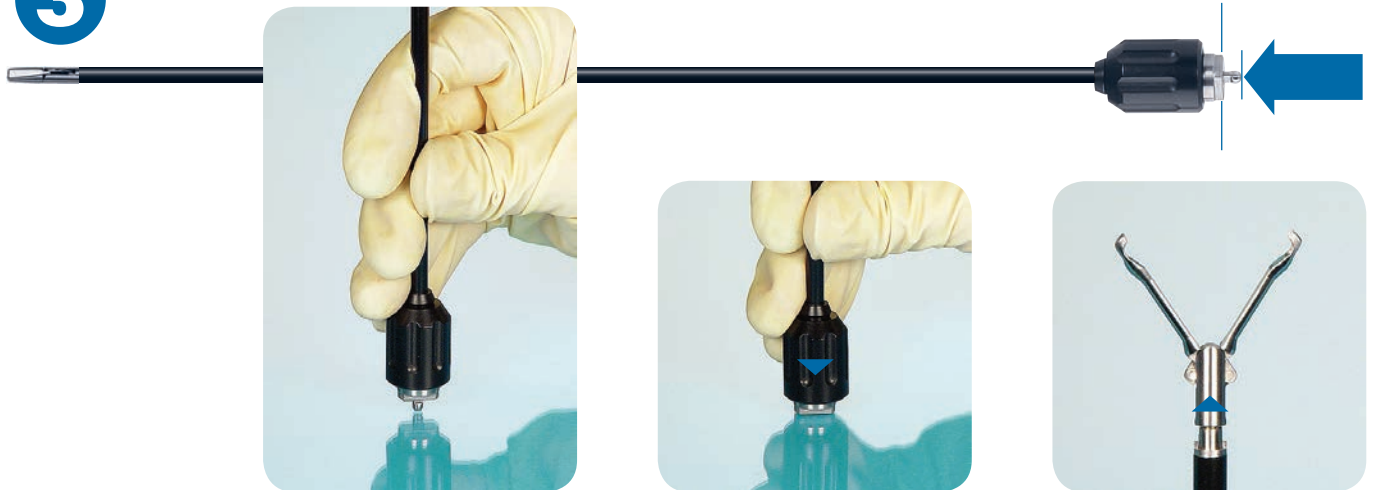

4



Ø 5 mm



Tube Shaft, insulated	shaft length: 330 mm
without LUER Lock	with LUER Lock
R030 - 050330 - 000	R030 - 050330 - 000 L



Tube Shaft, insulated	shaft length: 360 mm
without LUER Lock	with LUER Lock
R030 - 050360 - 000	R030 - 050360 - 000 L



Tube Shaft, insulated	shaft length: 450 mm
without LUER Lock	with LUER Lock
R030 - 050450 - 000	R030 - 050450 - 000 L

Ø 10 mm



Tube Shaft, insulated	shaft length: 330 mm
cylindrical	reduce to Ø 5 mm
R030 - 100330 - 000	R030 - 100330 - 000 5



Tube Shaft, insulated, for adipose patients	shaft length: 360 mm
cylindrical	reduce to Ø 5 mm
R030 - 100360 - 000	R030 - 100360 - 000 5



Tube Shaft, insulated, for adipose patients	shaft length: 450 mm
cylindrical	reduce to Ø 5 mm
R030 - 100450 - 000	R030 - 100450 - 000 5

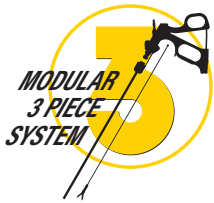

Carbon Handles

more details at the beginning of the chapter

Stainless steel Handles

more details at the beginning of the chapter

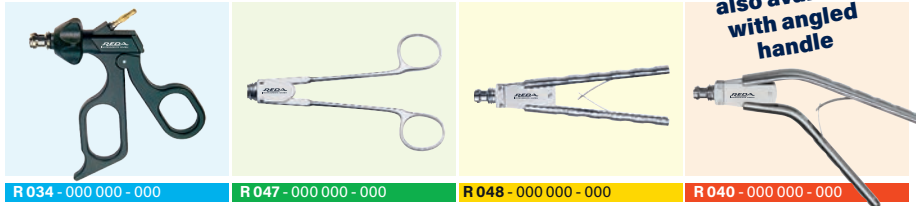

also available with angled handle

Ø 5 mm



R 034 - 000 000 - 000 R 047 - 000 000 - 000 R 048 - 000 000 - 000 R 040 - 000 000 - 000

METZENBAUM preparation scissors, straight, double action jaws

↔ 18 mm

Working length	Working insert alone	Complete instrument		
330 mm	R040-050330-110	R044-050330-110	R057-050330-110	R058-050330-110
360 mm	R040-050360-110	R044-050360-110	R057-050360-110	R058-050360-110
450 mm	R040-050450-110	R044-050450-110	R057-050450-110	R058-050450-110



METZENBAUM preparation scissors, curved, double action jaws

↔ 17 mm

Working length	Working insert alone	Complete instrument		
330 mm	R040-050330-112	R044-050330-112	R057-050330-112	R058-050330-112
360 mm	R040-050360-112	R044-050360-112	R057-050360-112	R058-050360-112
450 mm	R040-050450-112	R044-050450-112	R057-050450-112	R058-050450-112



Preparation scissors „WONDERCUT“, curved, double action jaws

↔ 20 mm

Working length	Working insert alone	Complete instrument		
330 mm	R040-050330-113	R044-050330-113	R057-050330-113	R058-050330-113
360 mm	R040-050360-113	R044-050360-113	R057-050360-113	R058-050360-113
450 mm	R040-050450-113	R044-050450-113	R057-050450-113	R058-050450-113



METZENBAUM preparation scissors, strong version, serrated, curved, double action jaws

↔ 17 mm

Working length	Working insert alone	Complete instrument		
330 mm	R040-050330-125	R044-050330-125	R057-050330-125	R058-050330-125
360 mm	R040-050360-125	R044-050360-125	R057-050360-125	R058-050360-125
450 mm	R040-050450-125	R044-050450-125	R057-050450-125	R058-050450-125



METZENBAUM preparation scissors, soft, curved, double action jaws

↔ 20 mm

Working length	Working insert alone	Complete instrument		
330 mm	R040-050330-122	R044-050330-122	R057-050330-122	R058-050330-122
360 mm	R040-050360-122	R044-050360-122	R057-050360-122	R058-050360-122
450 mm	R040-050450-122	R044-050450-122	R057-050450-122	R058-050450-122



also available
with angled
handle

Carbon Handles

more details at the beginning of the chapter

Stainless steel Handles

more details at the beginning of the chapter

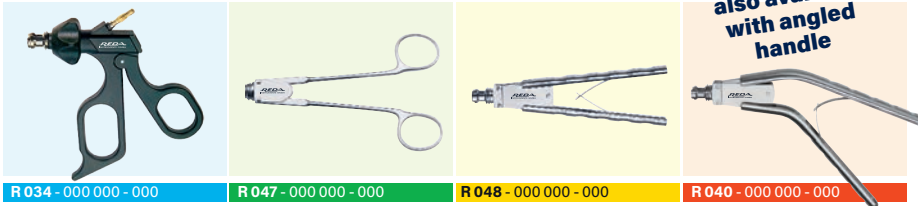

Ø 5 mm



10,5 mm

Peritoneal scissors, serrated, straight, single action jaws

R 034 - 000 000 - 000

R 047 - 000 000 - 000

R 048 - 000 000 - 000

R 040 - 000 000 - 000

Working length	Working insert alone	Complete instrument		
330 mm	R040-050330-114	R044-050330-114	R057-050330-114	R058-050330-114
360 mm	R040-050360-114	R044-050360-114	R057-050360-114	R058-050360-114
450 mm	R040-050450-114	R044-050450-114	R057-050450-114	R058-050450-114



9 mm

Hook scissors, single action jaws

Working length	Working insert alone	Complete instrument		
330 mm	R040-050330-116	R044-050330-116	R057-050330-116	R058-050330-116
360 mm	R040-050360-116	R044-050360-116	R057-050360-116	R058-050360-116
450 mm	R040-050450-116	R044-050450-116	R057-050450-116	R058-050450-116



5,5 mm

Micro scissors, straight, single action jaws

Working length	Working insert alone	Complete instrument		
330 mm	R040-050330-118	R044-050330-118	R057-050330-118	R058-050330-118
360 mm	R040-050360-118	R044-050360-118	R057-050360-118	R058-050360-118
450 mm	R040-050450-118	R044-050450-118	R057-050450-118	R058-050450-118



5,3 mm

Micro scissors, curved, single action jaws

Working length	Working insert alone	Complete instrument		
330 mm	R040-050330-120	R044-050330-120	R057-050330-120	R058-050330-120
360 mm	R040-050360-120	R044-050360-120	R057-050360-120	R058-050360-120
450 mm	R040-050450-120	R044-050450-120	R057-050450-120	R058-050450-120

Carbon Handles

more details at the beginning of the chapter

Stainless steel Handles

more details at the beginning of the chapter

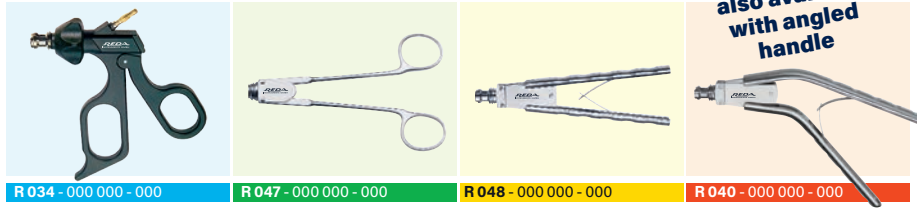

also available
with angled
handle

Ø 10 mm



↔ 18mm

MAYO operating scissors, single action jaws

Working length	Working insert alone	Complete instrument		
330 mm	R040-100330-710	R044-100330-710	R057-100330-710	R058-100330-710
360 mm	R040-100360-710	R044-100360-710	R057-100360-710	R058-100360-710
450 mm	R040-100450-710	R044-100450-710	R057-100450-710	R058-100450-710

Carbon Handles

more details at the beginning of the chapter

Stainless steel Handles

more details at the beginning of the chapter

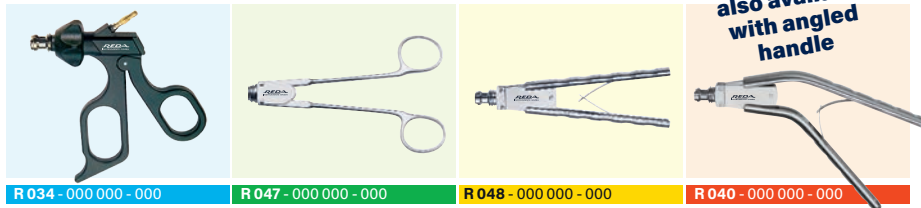

Ø 5 mm



BLAKESLEY tumor forceps, pointed, single action jaws

↔ 15 mm

Working length	Working insert alone	Complete instrument		
330 mm	R040-050330-268	R044-050330-268	R057-050330-268	R058-050330-268
360 mm	R040-050360-268	R044-050360-268	R057-050360-268	R058-050360-268
450 mm	R040-050450-268	R044-050450-268	R057-050450-268	R058-050450-268



Biopsy cup, sharp, without thorn, double action jaws

↔ 8 mm

Working length	Working insert alone	Complete instrument		
330 mm	R040-050330-310	R044-050330-310	R057-050330-310	R058-050330-310
360 mm	R040-050360-310	R044-050360-310	R057-050360-310	R058-050360-310
450 mm	R040-050450-310	R044-050450-310	R057-050450-310	R058-050450-310



Biopsy cup, sharp, with thorn, double action jaws

↔ 8 mm

Working length	Working insert alone	Complete instrument		
330 mm	R040-050330-312	R044-050330-312	R057-050330-312	R058-050330-312
360 mm	R040-050360-312	R044-050360-312	R057-050360-312	R058-050360-312
450 mm	R040-050450-312	R044-050450-312	R057-050450-312	R058-050450-312



Alligator, cup, grasping and biopsy forceps, double action jaws

↔ 11 mm

Working length	Working insert alone	Complete instrument		
330 mm	R040-050330-314	R044-050330-314	R057-050330-314	R058-050330-314
360 mm	R040-050360-314	R044-050360-314	R057-050360-314	R058-050360-314
450 mm	R040-050450-314	R044-050450-314	R057-050450-314	R058-050450-314

Carbon Handles

more details at the beginning of the chapter

Stainless steel Handles

more details at the beginning of the chapter



R 034 - 000 000 - 000



R 047 - 000 000 - 000

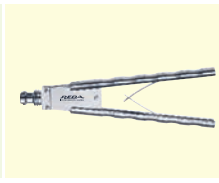

R 048 - 000 000 - 000



R 040 - 000 000 - 000

also available
with angled
handle

Ø 5 mm



Biopsy cup, long, single action jaws

↔ 14,5 mm

Working length	Working insert alone	Complete instrument		
330 mm	R040-050330-316	R044-050330-316	R057-050330-316	R058-050330-316
360 mm	R040-050360-316	R044-050360-316	R057-050360-316	R058-050360-316
450 mm	R040-050450-316	R044-050450-316	R057-050450-316	R058-050450-316



Biopsy cup, long, with thorn, single action jaws

↔ 14,5 mm

Working length	Working insert alone	Complete instrument		
330 mm	R040-050330-318	R044-050330-318	R057-050330-318	R058-050330-318
360 mm	R040-050360-318	R044-050360-318	R057-050360-318	R058-050360-318
450 mm	R040-050450-318	R044-050450-318	R057-050450-318	R058-050450-318



Biopsy cup, tapering, fenestrated, single action jaws

↔ 10 mm

Working length	Working insert alone	Complete instrument		
330 mm	R040-050330-320	R044-050330-320	R057-050330-320	R058-050330-320
360 mm	R040-050360-320	R044-050360-320	R057-050360-320	R058-050360-320
450 mm	R040-050450-320	R044-050450-320	R057-050450-320	R058-050450-320



also available
with angled
handle

Carbon Handles

more details at the beginning of the chapter

Stainless steel Handles

more details at the beginning of the chapter

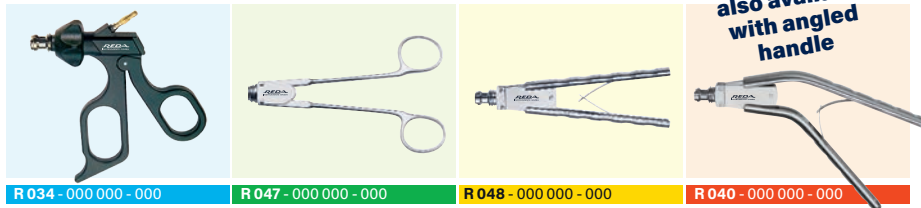

Ø 5 mm



Biopsy punch without thorn, single action jaws

Working length	Working insert alone	Complete instrument		
330 mm	R040-050330-410	R044-050330-410	R057-050330-410	R058-050330-410
360 mm	R040-050360-410	R044-050360-410	R057-050360-410	R058-050360-410
450 mm	R040-050450-410	R044-050450-410	R057-050450-410	R058-050450-410

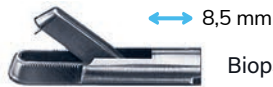

Biopsy punch with thorn, single action jaws

Working length	Working insert alone	Complete instrument		
330 mm	R040-050330-412	R044-050330-412	R057-050330-412	R058-050330-412
360 mm	R040-050360-412	R044-050360-412	R057-050360-412	R058-050360-412
450 mm	R040-050450-412	R044-050450-412	R057-050450-412	R058-050450-412

Carbon Handles

more details at the beginning of the chapter

Stainless steel Handles

more details at the beginning of the chapter

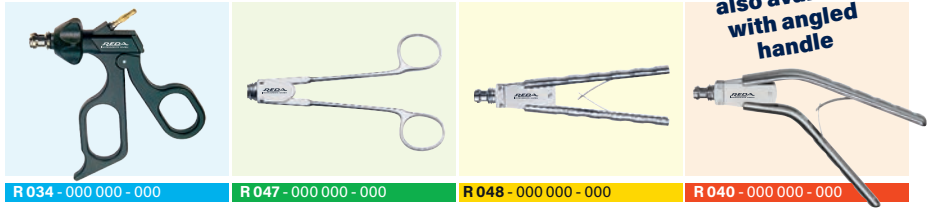

also available with angled handle

Ø 10 mm

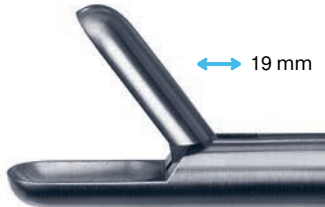

Cup forceps, big, sharp, without thorn, single action jaws

Working length	Working insert alone	Complete instrument		
330 mm	R040-100330-810	R044-100330-810	R057-100330-810	R058-100330-810
360 mm	R040-100360-810	R044-100360-810	R057-100360-810	R058-100360-810
450 mm	R040-100450-810	R044-100450-810	R057-100450-810	R058-100450-810

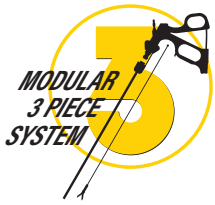

Ø 5 und 10 mm



Mechanical snap-action coupling !

The Ø 5 and 10 mm modular REDA laparoscopic instruments have a unique snap-action coupling which, offering the combined advantage of the speediest possible assembly and a long service life.

The union of the working insert and sleeve shaft is achieved by simply inserting the components axially into each other. A simple click and you are ready!

The groove-and-tongue principle practically rules out the possibility of the locking mechanism coming undone, as is the case with conventional screw or bayonet connections.

REDA - simplicity is so clever !



Nut stopper

An nut on the sleeve shaft of REDA modular instruments prevents bothersome slipping or even the loss of the union nut.

REDA - detail is the decisive factor !

Ø 3 / 5 / 10 mm

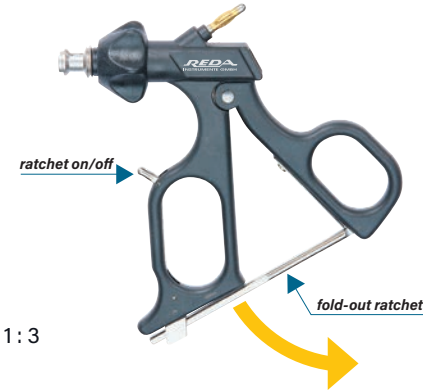

1:3

Ergonomic universal carbon handle with ratchet,
Lever for active or unactive ratchet, HF-connector Ø 4 mm male 45° lateral,
rotating head 360°, autoclavable

R033 - 000000 - 000



1:3

Ergonomic carbon handle with stepless ratchet,
ratchet by finger press resolve, HF-connector Ø 4 mm male 45° lateral,
rotating head 360°, autoclavable

R033P - 000000 - 000



1:3

Ergonomic carbon handle,
HF-connector Ø 4 mm male 45° lateral, rotating head 360°, autoclavable

R034 - 000000 - 000



1:3

Ergonomic universal carbon handle with ratchet,
Button for active or unactive ratchet, HF-connector Ø 4 mm male 45° lateral,
rotating head 360°, autoclavable

R032M - 000000 - 000

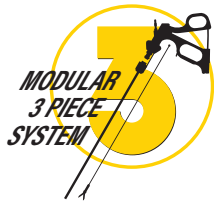

Laparoscopy -
Carbon Handles for Ø 3 / 5 / 10 mm tube shafts



Ø 3 / 5 / 10 mm

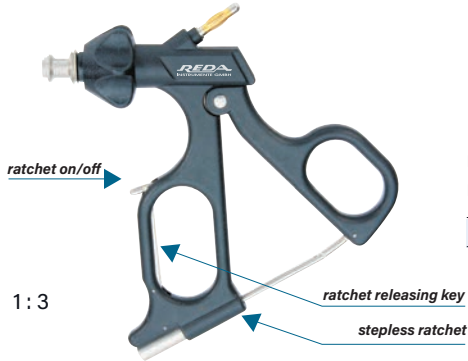

Ergonomic carbon handle with stepless ratchet,
ratchet activating / release lever, HF-connector Ø 4 mm male 45° lateral,
rotating head 360°, autoclavable

R033M - 000000 - 000

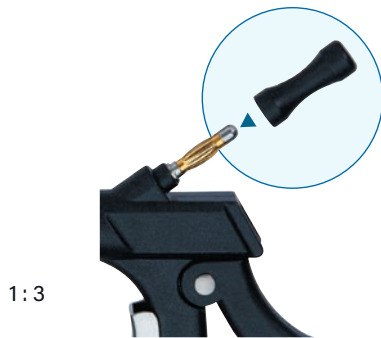

Protection cap for HF-connector Ø 4 mm

R030 - 000000

Ø 3 / 5 / 10 mm

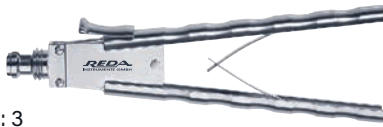

1:3

Axial handle, v-shaped type with spreading spring and ratchet

R038 - 000000 - 000

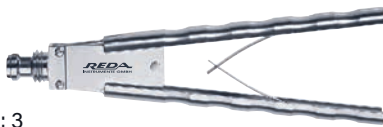

1:3

Axial handle, with spreading spring

R048 - 000000 - 000



1:3

Axial handle with rings and ratchet

R037 - 000000 - 000



1:3

Axial ring handle

R047 - 000000 - 000



Axial handle, v-shaped angled, type with spreading spring and ratchet

R039 - 000000 - 000



Axial handle, angled, with spreading spring

R040 - 000000 - 000

1



2

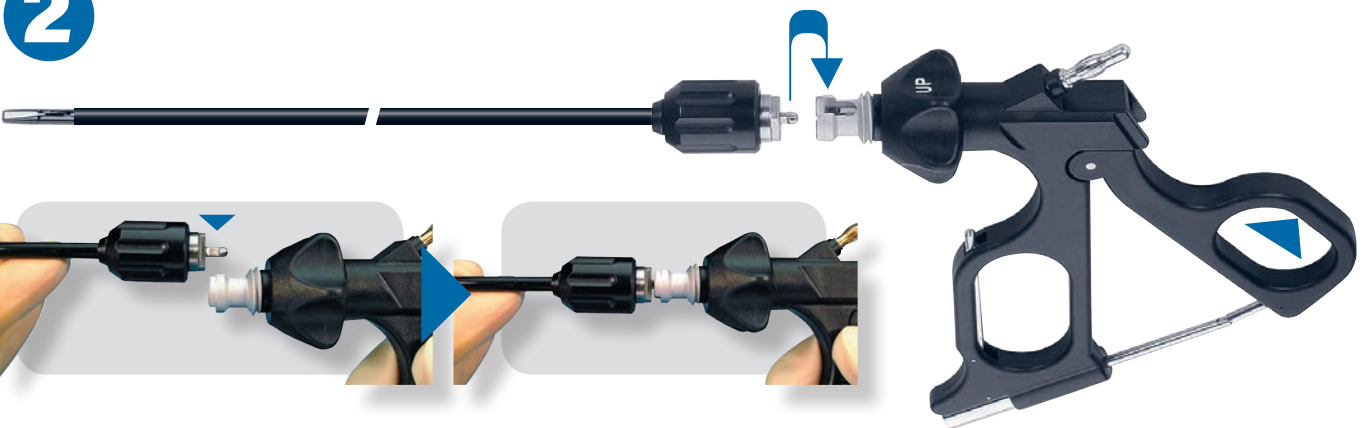

3

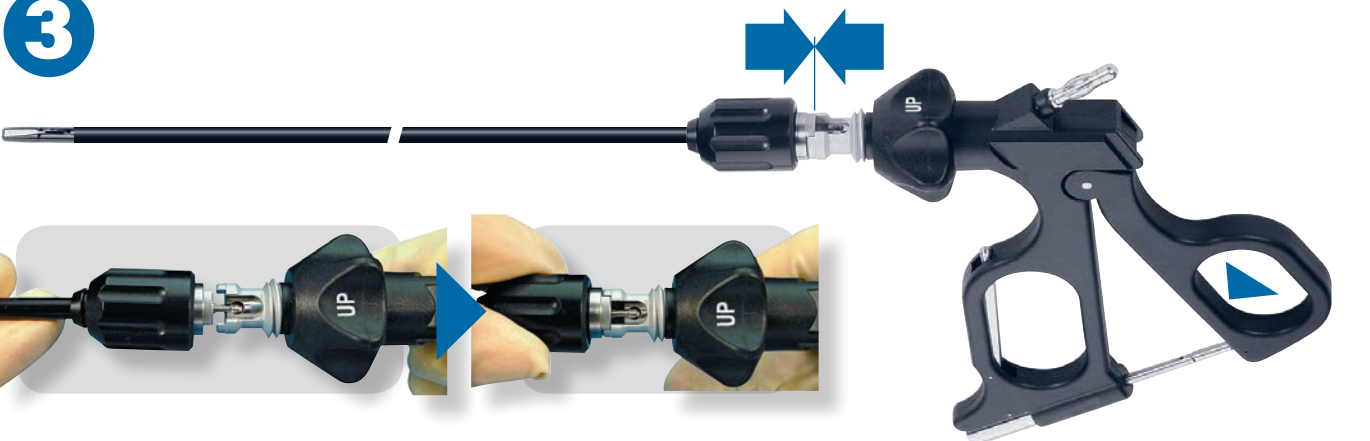

4



1



2

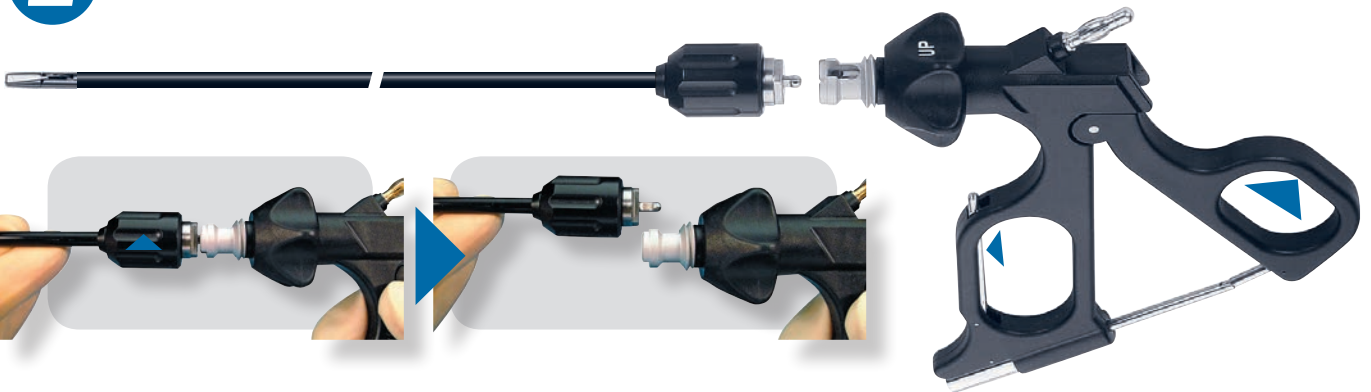

3



4



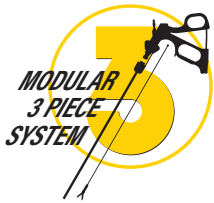



Ø 5 mm



Tube Shaft, insulated shaft length: **330 mm**
 without LUER Lock with LUER Lock
R030 - 050330 - 000 **R030 - 050330 - 000 L**

Tube Shaft, insulated shaft length: **360 mm**
 without LUER Lock with LUER Lock
R030 - 050360 - 000 **R030 - 050360 - 000 L**





Tube Shaft, insulated shaft length: **450 mm**
 without LUER Lock with LUER Lock
R030 - 050450 - 000 **R030 - 050450 - 000 L**



Ø 10 mm



Tube Shaft, insulated shaft length: **330 mm**
 cylindrical reduce to Ø 5 mm
R030 - 100330 - 000 **R030 - 100330 - 000 5**

Tube Shaft, insulated, for adipose patients shaft length: **360 mm**
 cylindrical reduce to Ø 5 mm
R030 - 100360 - 000 **R030 - 100360 - 000 5**





Tube Shaft, insulated, for adipose patients shaft length: **450 mm**
 cylindrical reduce to Ø 5 mm
R030 - 100450 - 000 **R030 - 100450 - 000 5**

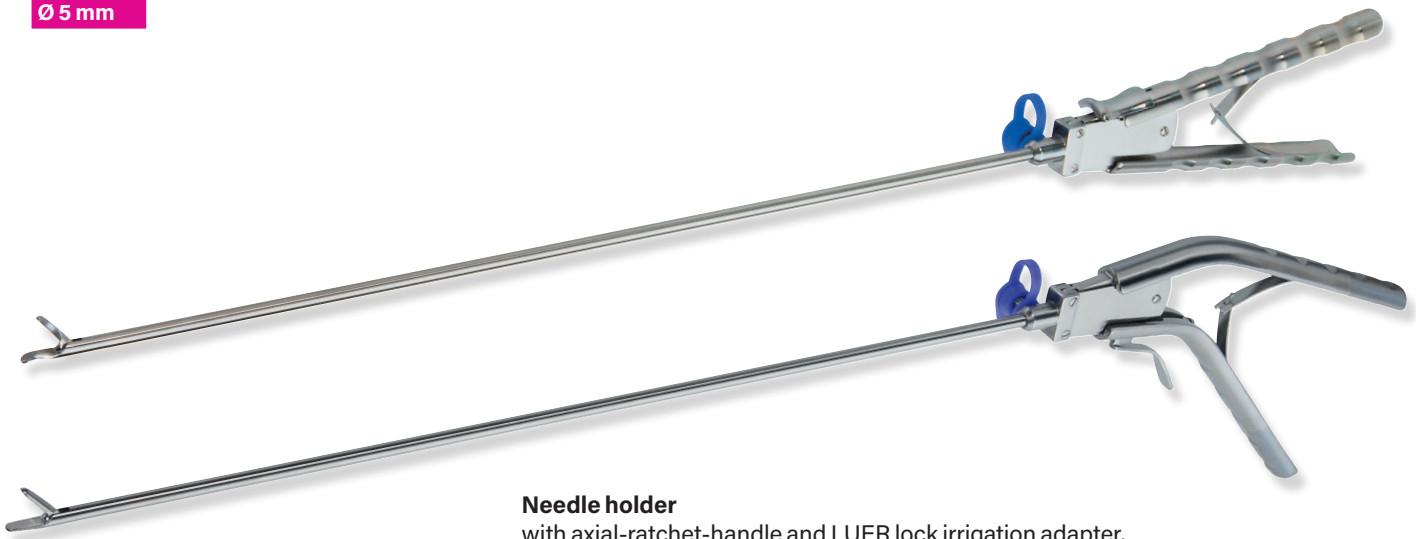

INSTRUMENTE GMBH

Ø 5 mm



Needle holder
with axial-ratchet-handle and LUER lock irrigation adapter,
Ø 5 mm, working length 330 mm - four jaw types available.



Needle holder, straight,
with inserted tungsten carbide, crosswise teeth, single action jaws

Working length	Handle, straight	Handle, angled
330 mm	R058-0533-350	R059-0533-350
450 mm	R058-0545-350	R059-0545-350



Needle holder, curved left,
with inserted tungsten carbide, crosswise teeth, single action jaws

Working length	Handle, straight	Handle, angled
330 mm	R058-0533-352	R059-0533-352
450 mm	R058-0545-352	R059-0545-352



Needle holder, curved right,
with inserted tungsten carbide, crosswise teeth, single action jaws

Working length	Handle, straight	Handle, angled
330 mm	R058-0533-354	R059-0533-354
450 mm	R058-0545-354	R059-0545-354



Needle holder/-positioner, convex/concave shaped jaws, with fixation teeth,
straight, with wolfram-carbide-coated tips, single action jaws

Working length	Handle, straight	Handle, angled
330 mm	R058-0533-360	R059-0533-360

Carbon Handles

more details at the beginning of the chapter

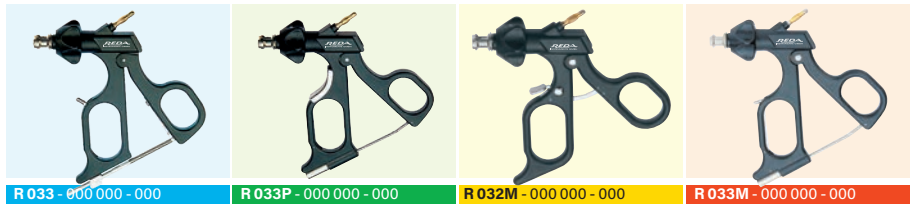

Ø 5 mm

R 033 - 000 000 - 000

R 033P - 000 000 - 000

R 032M - 000 000 - 000

R 033M - 000 000 - 000



↔ 15 mm

Needleholder with inserted tungsten carbide, straight, single action jaws

Working length	Working insert alone	Complete instrument			
330 mm	R050-050330-350	R053-050330-350	R053P-050330-350	R051-050330-350	R052-050330-350
360 mm	R050-050360-350	R053-050360-350	R053P-050360-350	R051-050360-350	R052-050360-350
450 mm	R050-050450-350	R053-050450-350	R053P-050450-350	R051-050450-350	R052-050450-350



↔ 11 mm

Needleholder with inserted tungsten carbide, curved left, single action jaws

Working length	Working insert alone	Complete instrument			
330 mm	R050-050330-352	R053-050330-352	R053P-050330-352	R051-050330-352	R052-050330-352
360 mm	R050-050360-352	R053-050360-352	R053P-050360-352	R051-050360-352	R052-050360-352
450 mm	R050-050450-352	R053-050450-352	R053P-050450-352	R051-050450-352	R052-050450-352



↔ 13 mm

Needleholder with inserted tungsten carbide, curved right, single action jaws

Working length	Working insert alone	Complete instrument			
330 mm	R050-050330-354	R053-050330-354	R053P-050330-354	R051-050330-354	R052-050330-354
360 mm	R050-050360-354	R053-050360-354	R053P-050360-354	R051-050360-354	R052-050360-354
450 mm	R050-050450-354	R053-050450-354	R053P-050450-354	R051-050450-354	R052-050450-354



↔ 14,5 mm

Needleholder/-positioner insert, convex/concav shaped jaws with fixation-teeth, Wolfram-Karbit finish, single action jaws

Working length	Working insert alone	Complete instrument			
330 mm	R050-050330-360	R053-050330-360	R053P-050330-360	R051-050330-360	R052-050330-360
360 mm	R050-050360-360	R053-050360-360	R053P-050360-360	R051-050360-360	R052-050360-360
450 mm	R050-050450-360	R053-050450-360	R053P-050450-360	R051-050450-360	R052-050450-360

Stainless steel Handles
more details at the beginning of the chapter



Ø 5 mm



Needleholder with inserted tungsten carbide, straight, single action jaws

¼

Complete instrument

			Working length mm
R057-050330-350	R058-050330-350	R059-050330-350	330
R057-050360-350	R058-050360-350	R059-050360-350	360
R057-050450-350	R058-050450-350	R059-050450-350	450



Needleholder with inserted tungsten carbide, curved left, single action jaws

¼

Complete instrument

			Working length mm
R057-050330-352	R058-050330-352	R059-050330-352	330
R057-050360-352	R058-050360-352	R059-050360-352	360
R057-050450-352	R058-050450-352	R059-050450-352	450



Needleholder with inserted tungsten carbide, curved right, single action jaws

¼

Complete instrument

			Working length mm
R057-050330-354	R058-050330-354	R059-050330-354	330
R057-050360-354	R058-050360-354	R059-050360-354	360
R057-050450-354	R058-050450-354	R059-050450-354	450



Needleholder/-positioner insert, convex/concav shaped jaws with fixation-teeth, Wolfram-Karbit finish, single action jaws

¼

Complete instrument

			Working length mm
R057-050330-360	R058-050330-360	R059-050330-360	330
R057-050360-360	R058-050360-360	R059-050360-360	360
R057-050450-360	R058-050450-360	R059-050450-360	450

Ø 5 mm

Romeo needleholder convex/concav
for optimum grasp of needles 5 mm Ø, 310 mm working length, axial handle open w. ratchet, LL-cleaning-port

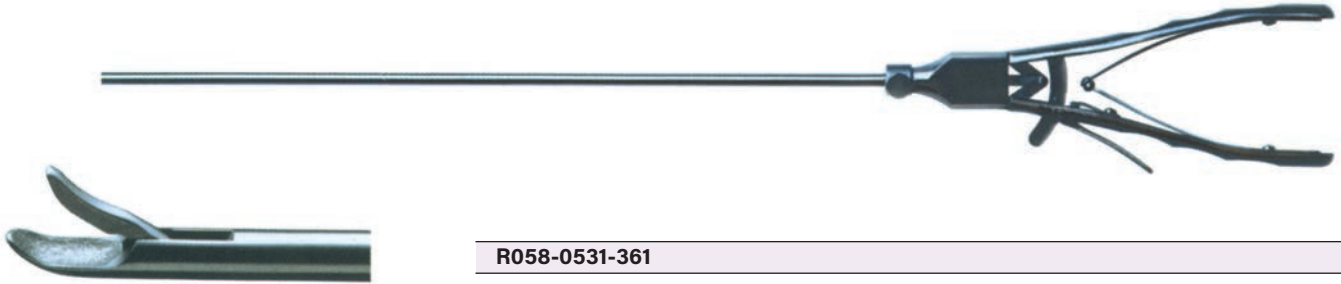

R058-0531-361

Ø 2,8 mm

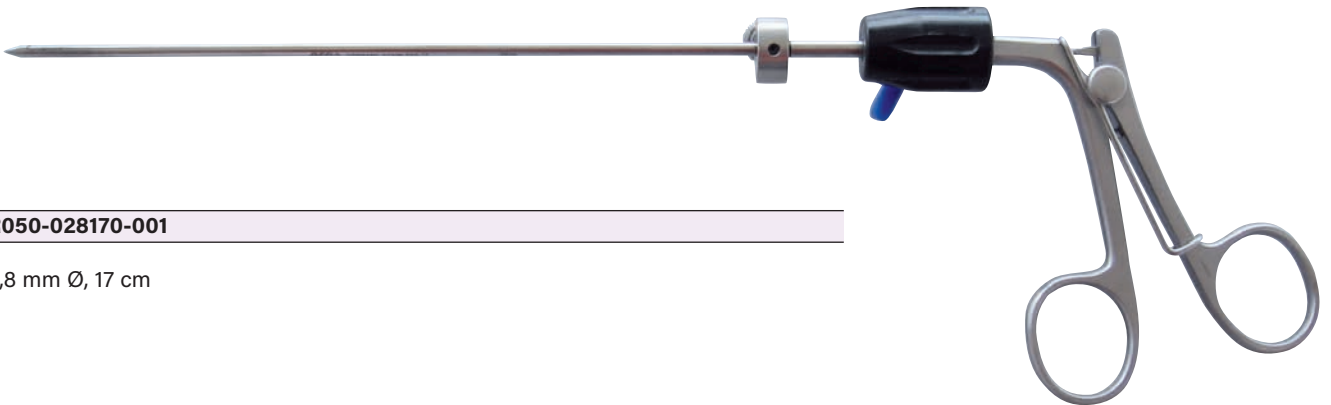

R050-028170-001

2,8 mm Ø, 17 cm

Ø 4 mm

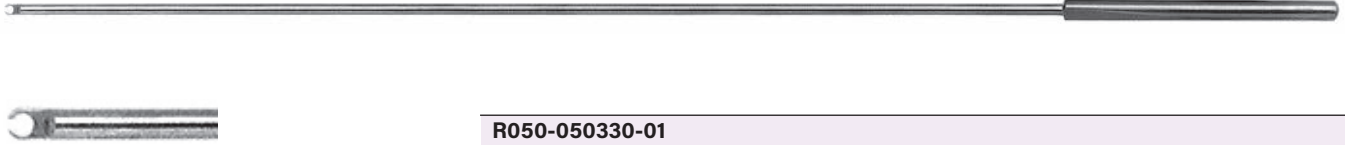

R050-050330-01

Knot tier with eye 4 mm Ø, 330 mm working length

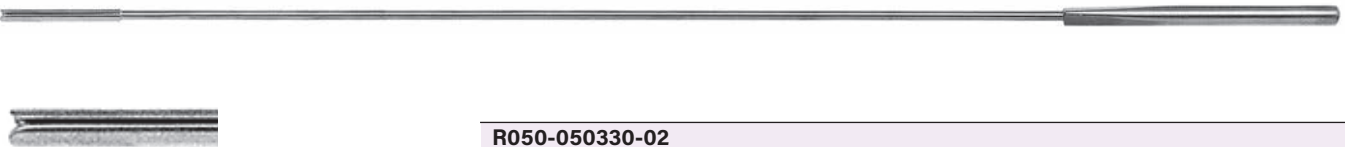

R050-050330-02

Knot guide with slot 4 mm Ø, 330 mm working length

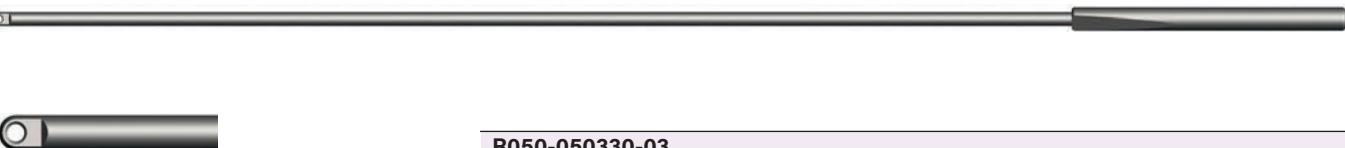

R050-050330-03

Knot pusher with closed eye 4 mm Ø, 330 mm working length

Ø 2,3 mm



R050-050340-00

The fascia-suture assisting device („fsad“) 2,3 mm Ø, 140 mm working length

Pic. 1



Push down the ring handle so that the needle is positioned outside the cannula. Set the thread into the „fsad“ and make sure that the thread is positioned in the middle. Pull back the ring handle with your thumb so that the catcher hook will be retracted into the cannula.

Pic. 3

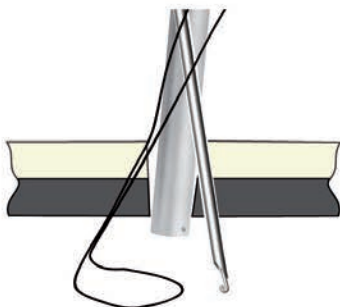

Now penetrate the „fsad“ on the other side of the Trocar (Pic. 2). - Please make sure again that the catcher hook is retracted during this procedure. When you have come through the subcutaneous tissue push down the ring handle so that the catcher hook comes out. Take the loose end of the thread by making use of the catcher-hook.

Pic. 5

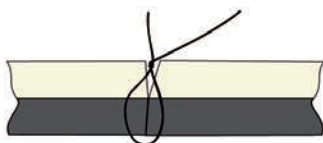

Knot the thread tightly in the subcutaneous tissue. This ensures an easy and safe handling of the abdominal wall closure.

Pic. 2

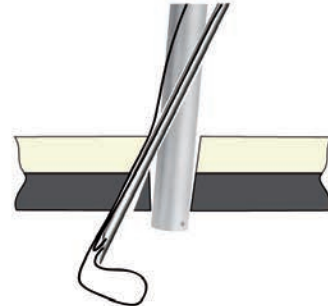

Penetrate the „fsad“ through the subcutaneous tissue (using the incision of the trocar) in the abdominal wall. Make sure that the catcher hook is always retracted during this procedure. After that, push down the ring handle so that the catcher hook comes out of the cannula. Now you can release the thread. Then retract the catcher hook by pulling the ring handle and extract the „fsad“

Pic. 4

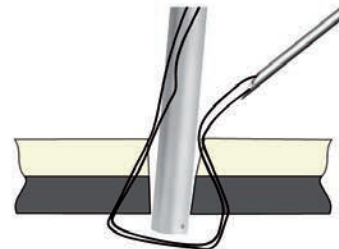

Pull the ring handle to retract the catcher hook again. Then remove the „fsad“ with the thread followed by the extraction of the trocar sleeve.

Ø 5 mm

Clip applying forceps, 5 mm Ø, 330 mm working length, detachable (3-parts), 360° rotatable, for TITAN-Clips

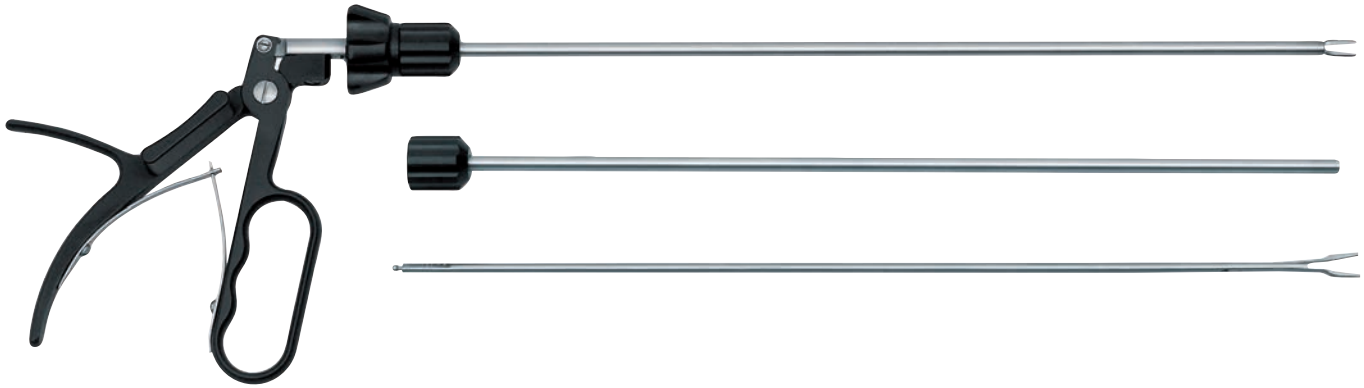

for Clips-Type	Forceps complete	Insert alone	Handle alone	Shaft tube alone
Ethicon - small	R056-050330-01	R056-050000-01	R056-050000-00	R056-050330-00
Ethicon - medium	R056-050330-02	R056-050000-02		
Weck - small	R056-050330-11	R056-050000-11		
Weck - medium	R056-050330-12	R056-050000-12		
Pilling - small	R056-050330-21	R056-050000-21		
Pilling - medium	R056-050330-22	R056-050000-22		
Horizon - small	R056-050330-41	R056-050000-41		
Horizon - medium	R056-050330-42	R056-050000-42		

Ø 10 mm

Clip applying forceps, 10 mm Ø, 330 mm working length, 360° rotatable, with LL-rinsing channel, for TITAN-Clips



for Clips-Type	
Ethicon - small	R055-100330-01
Ethicon - medium	R055-100330-02
Ethicon - medium-large	R055-100330-03
Ethicon - large	R055-100330-04
Weck - small	R055-100330-11
Weck - medium	R055-100330-12
Weck - medium-large	R055-100330-13
Pilling - small	R055-100330-21
Pilling - medium	R055-100330-22
Pilling - medium-large	R055-100330-23

for Clips-Type	
SLS - small	R055-100330-31
SLS - medium	R055-100330-32
SLS - medium-large	R055-100330-33
SLS - large	R055-100330-34
Horizon - small	R055-100330-41
Horizon - medium	R055-100330-42
Horizon - medium-large	R055-100330-43
Horizon - large	R055-100330-44

Ø 10 mm

Clip applying forceps, 10 mm Ø, 330 mm working length, detachable (3-parts), 360° rotatable, for TITAN-Clips

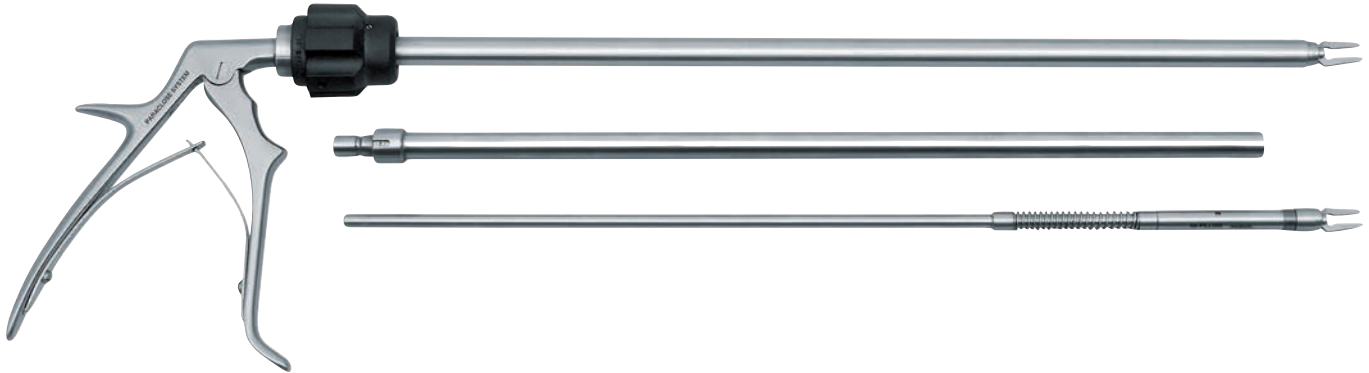

for Clips-Type	Forceps complete	Insert alone	Handle alone	Shaft tube alone
Ethicon - small	R056-100330-01	R056-100000-01	R056-100000-00	R056-100330-00
Ethicon - medium	R056-100330-02	R056-100000-02		
Ethicon - medium-large	R056-100330-03	R056-100000-03		
Ethicon - large	R056-100330-04	R056-100000-04		
Weck - small	R056-100330-11	R056-100000-11		
Weck - medium	R056-100330-12	R056-100000-12		
Weck - medium-large	R056-100330-13	R056-100000-13		
Weck - large	R056-100330-14	R056-100000-14		
Pilling - small	R056-100330-21	R056-100000-21		
Pilling - medium	R056-100330-22	R056-100000-22		
Pilling - medium-large	R056-100330-23	R056-100000-23		
SLS - small	R056-100330-31	R056-100000-31		
SLS - medium	R056-100330-32	R056-100000-32		
SLS - medium-large	R056-100330-33	R056-100000-33		
SLS - large	R056-100330-34	R056-100000-34		
Horizon - small	R056-100330-41	R056-100000-41		
Horizon - medium	R056-100330-42	R056-100000-42		
Horizon - medium-large	R056-100330-43	R056-100000-43		

Ø 10 mm

Endoscopic bulldog clamp applier, 10 mm Ø, 330 mm working length, 360° rotatable, with LL-rinsing channel

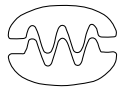

Bulldog clamps

	Jaws length	Straight	Curved
 2 x 3 Teeth	17 mm	R059-100-17	R059-101-17
	25 mm	R059-100-25	R059-101-25
	45 mm	R059-100-45	R059-101-45
	60 mm	R059-100-60	R059-101-60

Bulldog clamps (Satinsky) 2 x 3 teeth

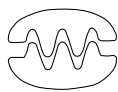
	Jaws length	Curved	Angled upwards
  2 x 3 Teeth	60 mm	R059-102-01	R059-103-01







INSTRUMENTE GMBH

Ø 5 mm





Monopolar electrode with small handle, HF-connector 5 mm male



	Type	Working length 330 mm	Working length 450 mm
	Button type electrode	R062-050330-001	R062-050450-001
	J-hook electrode	R062-050330-002	R062-050450-002
	90°-hook electrode	R062-050330-003	R062-050450-003
	Spatula electrode	R062-050330-004	R062-050450-004
	Needle electrode	R062-050330-005	R062-050450-005

Monopolar electrode with small handle, HF-connector 5 mm male



	Type	Working length 330 mm	Working length 450 mm
	Button type electrode	R060-050330-001	R060-050450-001
	J-hook electrode	R060-050330-002	R060-050450-002
	L-hook electrode	R060-050330-003	R060-050450-003
	Spatula electrode	R060-050330-004	R060-050450-004
	Needle electrode	R060-050330-005	R060-050450-005







R060-000000-000
Safety handle

Ø 5 mm

Monopolar electrode with large handle, HF-connector 5 mm male







	Type	Working length 340 mm	Working length 450 mm
	J-hook electrode	R061-050340-002	R061-050450-002
	L-hook electrode	R061-050340-003	R061-050450-003
	Spatula electrode	R061-050340-004	R061-050450-004
	Needle electrode	R061-050340-005	R061-050450-005

Ø 5 mm

Monopolar electrode with trumpet valve and LL-adaptor, HF-connector 5 mm male







	type	Working length 330 mm	Working length 450 mm
	Button type electrode	R063-050330-001	R063-050450-001
	J-hook electrode	R063-050330-002	R063-050450-002
	L-hook electrode	R063-050330-003	R063-050450-003
	Spatula electrode	R063-050330-004	R063-050450-004
	Needle electrode	R063-050330-005	R063-050450-005

Ø 5 mm

Monopolar electrode modular, adaptable on handles (see page 6/5, LL-connector)



	type	Working length 330 mm
	Button type electrode	R064-050330-001
	J-hook electrode	R064-050330-002
	L-hook electrode	R064-050330-003
	Spatula electrode	R064-050330-004
	Needle electrode	R064-050330-005



R064-050000-001

Electrode handle ergonomic design, with 2-way-valve



R064-050000-002

Adapter for electrode handle for connecting monopolar electrodes modular



R064-050000-006

Pistol Handle with Sliding Valve

for exchangeable electrodes, with rotatable adapter and sidewise HF-Connector two combined Luer-Lock / Tube Connectors

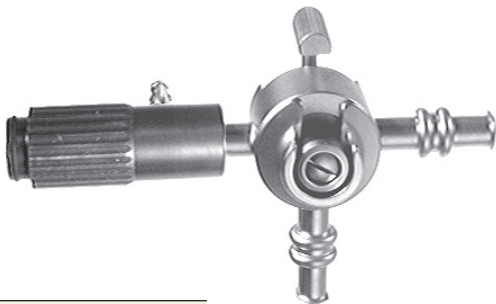

R064-050000-010

Suction-Irrigation-Sliding Valve with Electrode Adapter

for exchangeable electrodes, with rotatable adapter and side HF-Connector combined Luer-Lock / Tube Connector

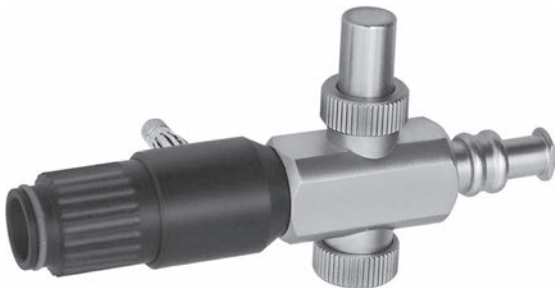

R064-050000-011

Trumpet Valve with Electrode Adapter

for exchangeable electrodes, with rotatable adapter and side HF-Connector combined Luer-Lock / Tube Connector

Ø 5 mm

Monopolar electrodes with exchangeable tip, dismountable 5 mm Ø, 320 mm working length

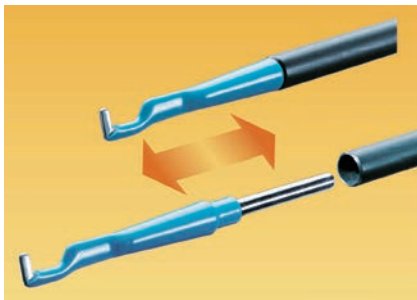

Handle alone

R062-050320-000

Outer tube insulated

R062-050320-099



Ball electrode

complete

assembly alone

R062-050320-001

R062-050000-001



J-hook electrode

R062-050320-002

R062-050000-002



L-hook electrode

R062-050320-003

R062-050000-003



Spatula electrode

R062-050320-004

R062-050000-004



Needle electrode

R062-050320-005

R062-050000-005



Lanzette electrode





R062-050320-006

R062-050000-006

Monopolar

Unit side

Instrument side

	Cable length Meter	female 4 mm Ø 
Erbe / Storz 5 mm Ø 	3	R060-050040-003
	5	R060-050040-005
Aesculap / Martin / Berchtold 4 mm Ø 	3	R060-040040-003
	5	R060-040040-005
Valleylab / Conmed / Soering Bowa / Bovie 8 mm Ø 	3	R060-080040-003
	5	R060-080040-005
Eschmann / Erbe T-Serie alte Geräte / old units 	3	R060-040040-203
	5	R060-040040-205

BIPOLAR



Ø 5 mm



Bipolar electrodes 340 mm working length



Ball electrode

R067-050340-001



J-hook electrode

R067-050340-002



L-hook electrode

R067-050340-003



Spatula electrode

R067-050340-004



Plate electrode

R067-050340-005

Ø 3 mm



Bipolar electrodes 3 mm Ø, 340 mm working length for fine coagulation of tissue and vessels



L-hook electrode

R068-030340-003



Needle electrode

R068-030340-010



V-shaped electrode

R068-030340-012

Ø 5 mm

For use in laparoscopy for grasping or cutting tissue during bipolar coagulation. This instrument is for connecting to the bipolar output of HF-generators with maximum power output 60 Watt. The electrode is 360° rotatable, there is no receding of the jaws when closing. This allows precise grasping or cutting of the tissue.

Standard handle
R066-000000-500



Ring handle
R066-000000-600



HIRSCH



Working length	Working insert alone	complete with handle	complete with handle
200 mm	R066-000200-501	R066-050200-501	R066-050200-601
340 mm	R066-000340-501	R066-050340-501	R066-050340-601
450 mm	R066-000450-501	R066-050450-501	R066-050450-601

Micro



Working length	Working insert alone	complete with handle	complete with handle
200 mm	R066-000200-507	R066-050200-507	R066-050200-607
340 mm	R066-000340-507	R066-050340-507	R066-050340-607
450 mm	R066-000450-507	R066-050450-507	R066-050450-607

Ø 5 mm

Standard handle
R066-000000-500



Ring handle
R066-000000-600



KLEPPINGER



Working length	Working insert alone	complete with handle	complete with handle
200 mm	R066-000200-508	R066-050200-508	R066-050200-608
340 mm	R066-000340-508	R066-050340-508	R066-050340-608
450 mm	R066-000450-508	R066-050450-508	R066-050450-608

Atraumatic 3 mm smooth



Working length	Working insert alone	complete with handle	complete with handle
200 mm	R066-000200-503	R066-050200-503	R066-050200-603
340 mm	R066-000340-503	R066-050340-503	R066-050340-603
450 mm	R066-000450-503	R066-050450-503	R066-050450-603

METZENBAUM scissors curved



Working length	Working insert alone	complete with handle	complete with handle
200 mm	R066-000200-509	R066-050200-509	R066-050200-609
340 mm	R066-000340-509	R066-050340-509	R066-050340-609
450 mm	R066-000450-509	R066-050450-509	R066-050450-609

Ø 5 mm

Standard handle
R066-000000-500



Ring handle
R066-000000-600



METZENBAUM scissors curved TC blades



Working length	Working insert alone	complete with handle	complete with handle
200 mm	R066-000200-510	R066-050200-510	R066-050200-610
340 mm	R066-000340-510	R066-050340-510	R066-050340-610
450 mm	R066-000450-510	R066-050450-510	R066-050450-610

MARYLAND



Working length	Working insert alone	complete with handle	complete with handle
200 mm	R066-000200-521	R066-050200-521	R066-050200-621
340 mm	R066-000340-521	R066-050340-521	R066-050340-621
450 mm	R066-000450-521	R066-050450-521	R066-050450-621

Outer shaft tube



Working length	
200 mm	R066-050200-001
340 mm	R066-050340-001
450 mm	R066-050450-001

Inner shaft tube



Working length	
200 mm	R066-050200-000
340 mm	R066-050340-000
450 mm	R066-050450-000



Adapter for european flat plug

R066-000000-002



Adapter for US-cables

R066-000000-012

Ø 5 mm



Handle
R067-000000-700



Shaft
R067-050340-700

Insert alone

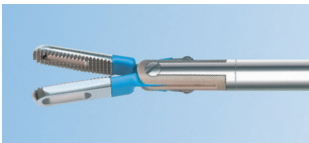

Large grasping forceps

R067-000340-713

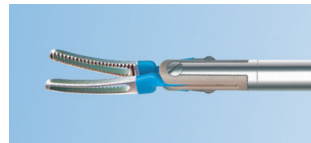

Grasping forceps, curved

R067-000340-724

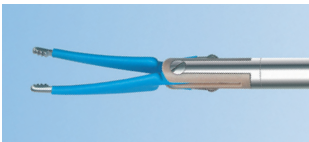

Forceps, curved

R067-000340-722

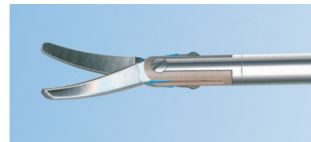

Scissors, curved

R067-000340-709



Delta Grasper



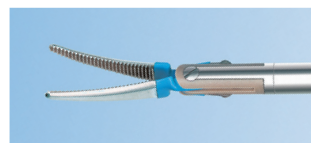



R067-000340-723



MARYLAND dissector, curved

R067-000340-721

Bipolar

Unit / Equipment side	Cable length Meter	Instrument side	
		Europe flat plug	
 Erbe / Storz 12,5 mm Ø	3	 R065-040125-003	 R065-040125-103
	5	R065-040125-005	R065-040125-105
 Martin / Berchtold 8 mm Ø AEscULAP Wolf	3	R065-020080-003	R065-020080-103
	5	R065-020080-005	R065-020080-105
 Valleylab / Lamidey / EMC	3	R065-040285-003	R065-040285-103
	5	R065-040285-005	R065-040285-105
 2-Pin U.S. Standard Eschmann	3	R065-040000-003	R065-040000-103
	5	R065-040000-005	R065-040000-105



Bipolar forceps with rotating handle

This new innovative design provides the surgeon with comfortable ergonomic handling in all working positions.

The handles rotate independently of the shaft, so the instrument can be controlled in a relaxed natural way, reducing fatigue and enabling precise handling and control during surgery.

Ø 5 mm

bipolar forceps with rotatable handle



Handle
R070-050200-01

Handle, lockable
R070-050200-02

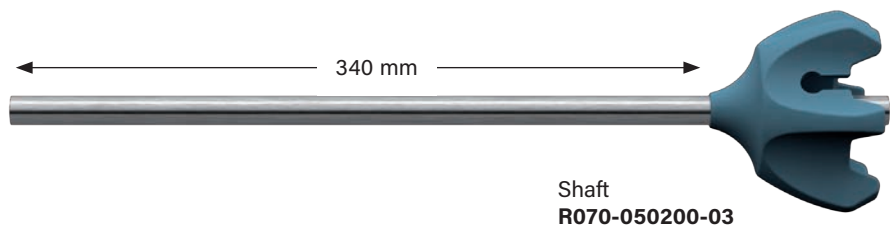

Shaft
R070-050200-03

Insert alone



Large grasping forceps
R070-050200-04



Scissors, curved
R070-050200-05



Grasping forceps,
fenestrated, curved
R070-050200-06



MARYLAND dissector, curved
R070-050200-07

Ø 5,0 mm

Suction-Irrigation-Cannula
with Sliding Valve and Roundhole
Sucker with Handle and 4 Holes



working length	complete
----------------	----------

330 mm	R072-050330-004 D
---------------	--------------------------

Handle with Sliding Valve

R072-000000-000

Roundhole Sucker with 4 Drillings and Handle
--

R070-050330-004 D

Ø 5,0 mm

Suction-Irrigation-Cannula

Roundhole Sucker
with Luer-Lock-Connection and Stop Cock
Suction Tube graduated, 16 Drillings



working length

450 mm R074-050450-016

working length

330 mm R074-050330-016

Suction-Irrigation-Tube

with Luer-Lock-Connection, 4 Drillings



working length

330 mm R075-050330-004

Ø 5,0 mm

Suction-Irrigation-Handle
with Luer-Lock-Connection

R073-000000-000

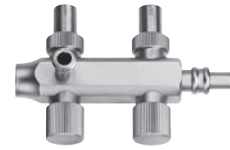

Suction-Irrigation-Handle
with Tube Connection

R071-000000-000

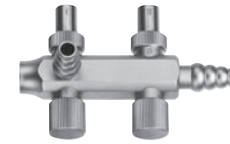

Suction-Irrigation-Handle
with Sliding Valve and
Tube Connection

R072-000000-000



Ø 5 / 10 mm

Suction-Irrigation-Tubes

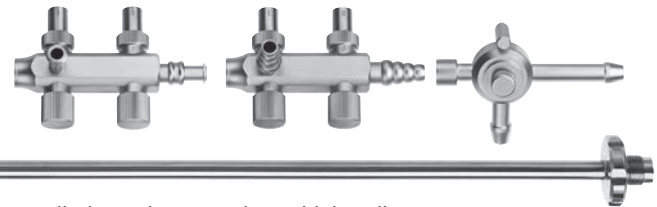

working length	Shaft tube alone		Roundhole Sucker, complete with handle
330 mm	R070-050330-004	4 Drillings, Ø 5 mm	R073-050330-004 R071-050330-004 R072-050330-004
330 mm	R070-050330-016	16 Drillings, Ø 5 mm	R073-050330-016 R071-050330-016 R072-050330-016
330 mm	R070-050330-032	32 Drillings, Ø 10 mm	R073-050330-032 R071-050330-032 R072-050330-032



working length	Shaft tube alone		Roundhole-Bee Hive Sucker, complete with handle
330 mm	R070-050330-048	48 Drillings, Ø 5 mm	R073-050330-048 R071-050330-048 R072-050330-048



working length	Shaft tube alone		Stump Bee Hive Sucker, complete with handle
330 mm	R070-050330-049	48 Drillings, Ø 5 mm	R073-050330-049 R071-050330-049 R072-050330-049
500 mm	R070-050500-049	48 Drillings, Ø 5 mm	R073-050500-049 R071-050500-049 R072-050500-049



working length	Shaft tube alone		Punction Needle Sucker, complete with handle
330 mm	R070-050330-002	Ø 5 mm	R073-050330-002 R071-050330-002 R072-050330-002



working length	Shaft tube alone		Aqua Dissector Cannula, complete with handle
330 mm	R070-050330-001	Ø 5 mm	R073-050330-001 R071-050330-001 R072-050330-001



working length	Shaft tube alone		Stump Sucker, complete with handle
330 mm	R070-050330-012	12 Drillings, Ø 5 mm	R073-050330-012 R071-050330-012 R072-050330-012

Ø 3,5 / 5 / 10 mm

Suction-Irrigation-Handle

with color-coding

- **20% less weight**
- **less individual parts**
- **color-coding**
blue - irrigation
green - suction



with large Tube-Connection and sidewise Tube-Luer-Lock-Connection

R078-000000-100 Handle

complete with both Suction-Irrigation-Tubes complete with Tube-Set Ø 5 mm / 10 mm

R078-000000-199 **R078-050330-116** **R078-100330-116**

- **two in one**
sidewise Tube-Luer-Lock-Connection



with small Tube-Connection and sidewise Tube-Luer-Lock-Connection

R079-000000-100 Handle

complete with both Suction-Irrigation-Tubes complete with Tube-Set Ø 5 mm / 10 mm

R079-000000-199 **R079-050330-116** **R079-100330-116**



working length

240 mm	R070-035240-116	Ø 3,5 mm
330 mm	R070-050330-116	Ø 5 mm
330 mm	R070-100330-116	Ø 10 mm
450 mm	R070-050450-116	Ø 5 mm
450 mm	R070-100450-116	Ø 10 mm

Suction-Irrigation-Handle
with 1 trumpet valve



R076-000000-200

Suction-Irrigation-Pistol-Handle
with sliding valve for exchangeable
shafts, two combined Luer-Lock,
Tube Connectors



R079-000000-200

Ø 3,0 mm

Suction-Irrigation-Tubes



working length Shaft tube alone

complete with 4 sidewise drillings

340 mm R070-030340-204

R076-030340-204

R079-030340-204

complete with 16 sidewise drillings

340 mm R070-030340-216

R076-030340-216

R079-030340-216

Ø 5,0 mm



working length Shaft tube alone

complete with 4 sidewise drillings

340 mm R070-050340-204

R076-050340-204

R079-050340-204

complete with 16 sidewise drillings

340 mm R070-050340-216

R076-050340-216

R079-050340-216

Ø 10 mm



working length Shaft tube alone

complete with 4 sidewise drillings

340 mm R070-100340-204

R076-100340-204

R079-100340-204

complete with 16 sidewise drillings

340 mm R070-100340-216

R076-100340-216

R079-100340-216

1 Handle
2 Functions

Suction-Irrigation

Monopolar Coagulation see page 6/4

Suction-Irrigation-Pistol-Handle

with two-way sliding valve and tube connections

- **ergonomic handle design**
- **enlarged suction channel**
- **straight passages for suction-irrigation liquid**
- **comfortable operation due to short swivel movement of sliding valve**

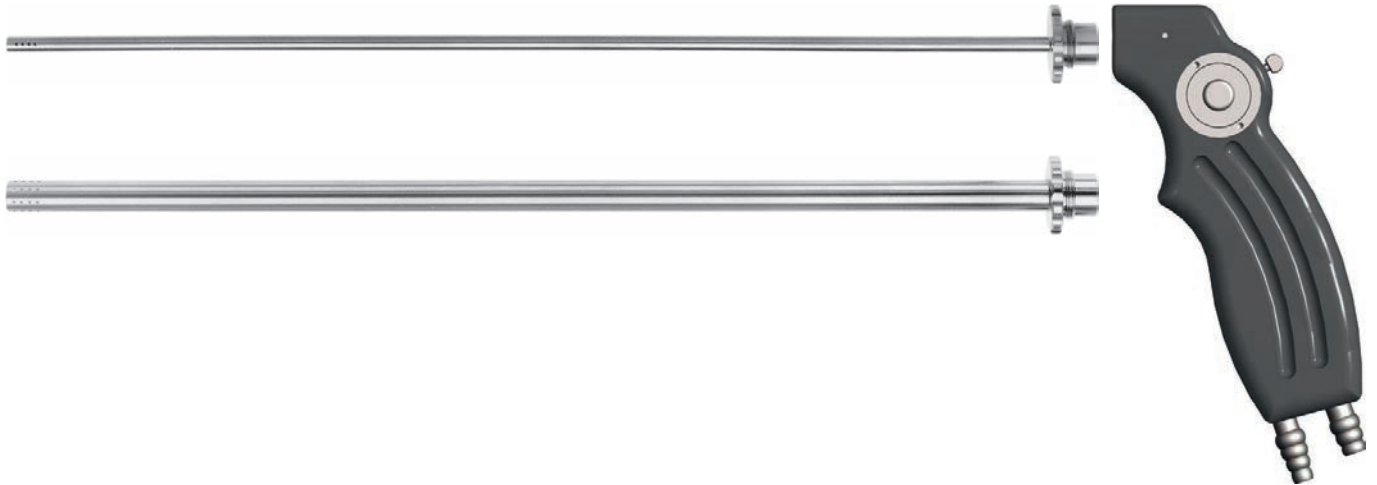

Handle

R064-050000-001

Ø 3 / 5 / 10 mm

Suction-Irrigation-Tubes

working length	Shaft tube alone	complete with Tube Ø 3,0 m with distal 4x4 hole
330 mm	R070-030330-416	R079-030330-416
		complete with Tube Ø 5,0 mm with distal 4x4 hole
330 mm	R070-050330-416	R079-050330-416
		complete with Tube Ø 10 mm with distal 4x4 hole
330 mm	R070-100330-416	R079-100330-416

Ø 5 mm



R075-050340-000

Complete set

R075-050340-016

Suction-Irrigation Tube 5 mm Ø with 2 lateral trumpet valves with LL-adapters, 340 mm working length, distal 4x1 hole, proximal with LL-adapter for laser fiber guide insert



R075-020390-000

Laser fiber guide insert alone, 391 mm

Ø 5 mm

Puncture- and Injection Needle 5 mm Ø distal with needle, proximal with LL-adapter



Needle Ø	330 mm working length	450 mm working length
0,7 mm	R075-050330-007	
0,9 mm	R075-050330-009	
1,2 mm	R075-050330-012	R075-050450-012
1,4 mm	R075-050330-014	R075-050450-014
1,5 mm	R075-050330-015	R075-050450-015
1,8 mm	R075-050330-018	R075-050450-018

Ø 6 mm

Puncture Tube for NaCl - Fluid, 6 mm Ø



working length	
160 mm	R940-5130-160
190 mm	R940-5130-190
235 mm	R940-5130-235

Ø 2 mm

Insufflation cannula 2 mm Ø, with LL-adapter



Needle working length

55 mm	R075-020055-001
70 mm	R075-020070-001
80 mm	R075-020080-001
100 mm	R075-020100-001
120 mm	R075-020120-001
130 mm	R075-020130-001
140 mm	R075-020140-001
150 mm	R075-020150-001
170 mm	R075-020170-001
180 mm	R075-020180-001
200 mm	R075-020200-001
230 mm	R075-020230-001

Ø 2,7 mm

High-Flow insufflation cannula 2,7 mm Ø, with LL-adapter



Needle working length

100 mm	R075-027100-001
120 mm	R075-027120-001
150 mm	R075-027150-001
170 mm	R075-027170-001

Ø 2 mm

Insufflation cannula acc. to Veress with stopcock and Luer-Lock-Connection **Stainless Steel**, 2 mm Ø



working length	
100 mm	R080-020100-001
120 mm	R080-020120-001
150 mm	R080-020150-001

Ø 2,7 mm

Insufflation cannula acc. to Veress **High-Flow**, stopcock and Luer-Lock-Connection **Stainless Steel**, 2,7 mm Ø



working length	
100 mm	R080-027100-001
120 mm	R080-027120-001
150 mm	R080-027150-001

Ø 6 FR



Cholangiography-catheter, 600 mm long

R080-020600-201

Ø 5 mm

Cholangiography fixation clamp with ratchet 5 mm Ø, with working channel, 330 mm working length



R081-050330-001

Ø 5 mm

Palpation probe graduated 5 mm Ø



working length

330 mm	R090-050330-001
450 mm	R090-050450-001

Two-Way-Stopcock for Contrast Medium

R070-000040-003

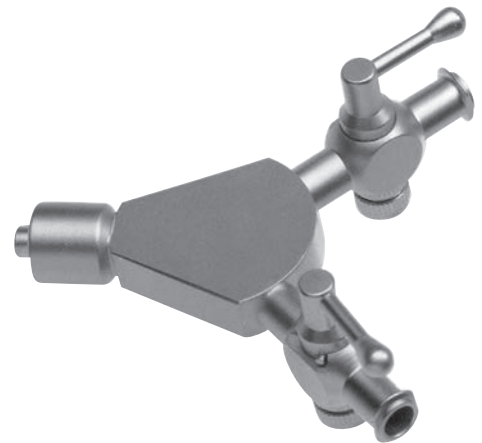

Ø 10 mm

Lever retractor 5-fingers spreadable, distal 80° movable, 10 mm Ø, 330 mm working length



R091-100330-005

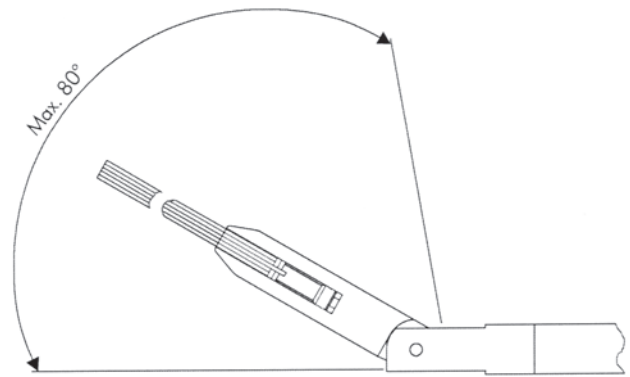
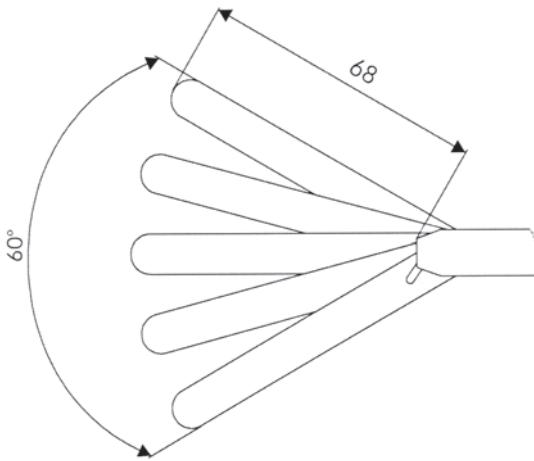

Endo-Retractor for elastic abdominal bands, blunt fenestrated tip, adjustable, 360 mm working length, LL-adpater for cleaning



Ø 5 mm



R094-050360-001

Ø 10 mm



R094-100360-001

Ø 5 mm

Endo-Retractor 5 mm Ø with 3 fingers spreadable 340 mm working length, LL-adapter for cleaning



R091-050340-003



adjustable

R092-050340-003

Ø 10 mm

Endo-Retractor 10 mm Ø with 5 fingers spreadable 380 mm working length, LL-adapter for cleaning



R091-100380-005



adjustable

R092-100380-005

Ø 5 mm

Endo-Retractor 5 mm Ø with 5 fingers spreadable, 340 mm working length rigid, 42 mm spreader, LL-adapter for cleaning



R091-050340-005

Endo-Retractor 5 mm Ø with 5 fingers spreadable a. adjustable, 340 mm working length, 55 mm spreader, LL-adapter for cleaning



R092-050340-005

Ø 5 mm



R093-050550-001



R093-050470-001

Speculum retractor, 3 blades for gall bladder extraction

R099-000250-003

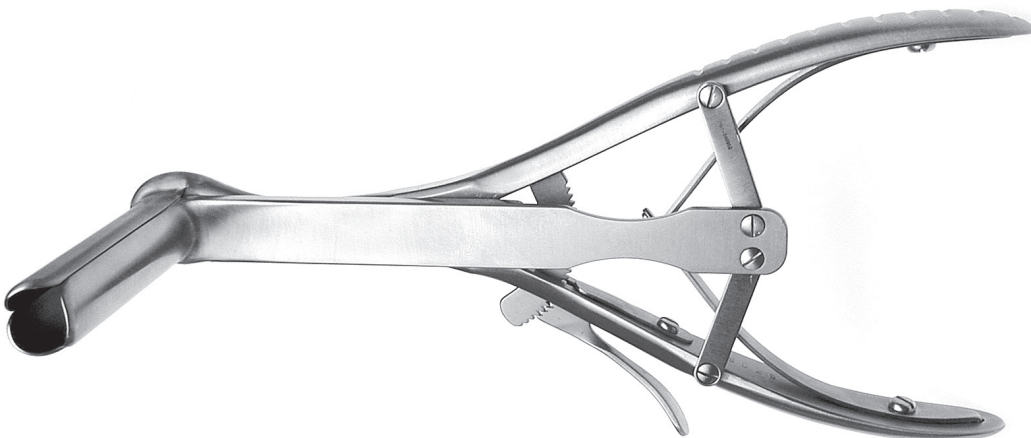
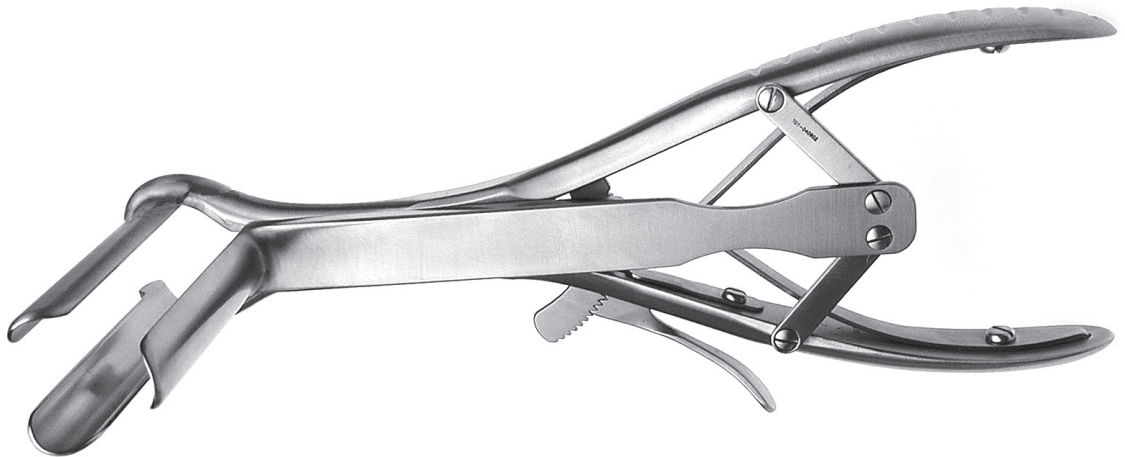

Ø 2,0

Laparoscopes with integrated fiberoptic
for illumination, autoclavable



diameter	working length	direction of view 0°
Ø 2,0 mm	187,5 mm	R010-020187-000

Ø 3,5 mm

Multi function valve trocar sleeve



diameter	working length	Art. No.
Ø 3,5 mm	70 mm	R023-035070-001

Standard trocar



diameter	for tube length	pyramidal	conical	conical blunt
Ø 3,5 mm	70 mm	R020-035070-001	R020-035070-002	R020-035070-003

Safety trocar
oblique end, conical blunt



diameter	for tube length	Art. No.
Ø 3,5 mm	70 mm	R020-035070-023

Ø 3,5 mm

HASSON automatic trocar sleeve with stopcock,
adjustable cone and suture holder at cone

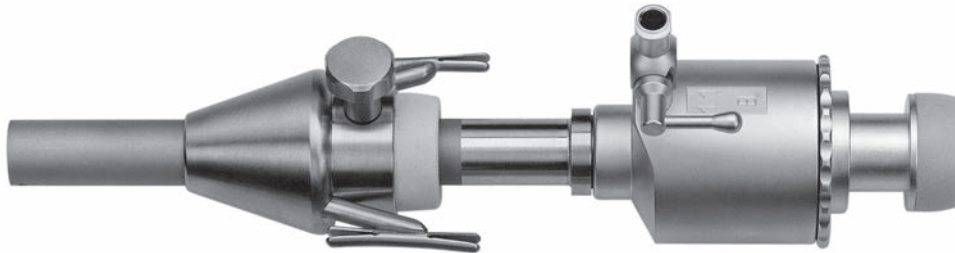

Ø	Cone alone
3,5 mm	R020-035500-001

Standard trocar
conical blunt



R020-035070-003

Ø 3,5 mm

Ø 3 mm



The working insert and tube shaft form a single component. Namely the Working Part with a LUER lock irrigation adapter

The working insert and tube shaft form a single component in 3 mm instruments, contrary to the arrangement in modular 5 and 10 mm REDA tube shaft instruments.

3 mm instruments have been developed principally for use in pediatrics and diagnostic laparoscopy and are fitted with a LUER lock irrigation adapter which achieves optimum cleansing results.

REDA - uncompromising safety !

Ø 3 / 5 / 10 mm

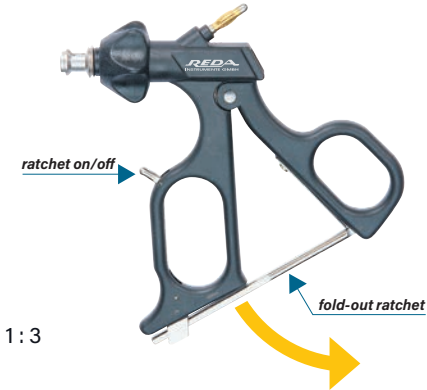

1:3

Ergonomic universal carbon handle with ratchet, Lever for active or unactive ratchet, HF-connector Ø 4 mm male 45° lateral, rotating head 360°, autoclavable

R033 - 000000 - 000

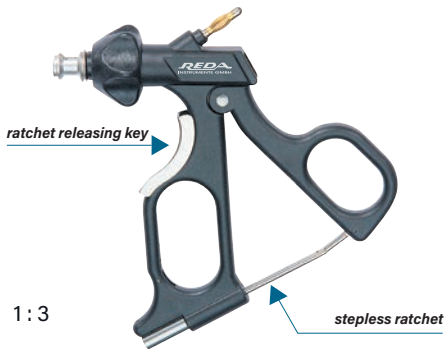

1:3

Ergonomic carbon handle with stepless ratchet, ratchet by finger press resolve, HF-connector Ø 4 mm male 45° lateral, rotating head 360°, autoclavable

R033P - 000000 - 000



1:3

Ergonomic carbon handle, HF-connector Ø 4 mm male 45° lateral, rotating head 360°, autoclavable

R034 - 000000 - 000



1:3

Ergonomic universal carbon handle with ratchet, Button for active or unactive ratchet, HF-connector Ø 4 mm male 45° lateral, rotating head 360°, autoclavable

R032M - 000000 - 000



Ø 3 / 5 / 10 mm

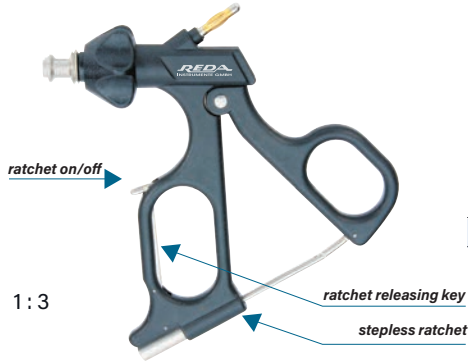

Ergonomic carbon handle with stepless ratchet, ratchet activating / release lever, HF-connector Ø 4 mm male 45° lateral, rotating head 360°, autoclavable

R033M - 000000 - 000

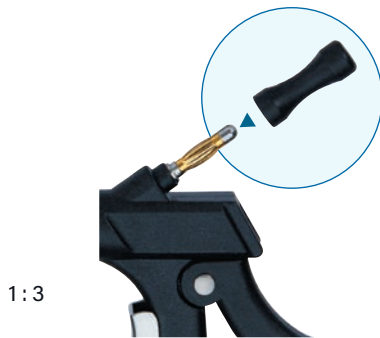

Protection cap for HF-connector Ø 4 mm

R030 - 000000

Ø 3 / 5 / 10 mm

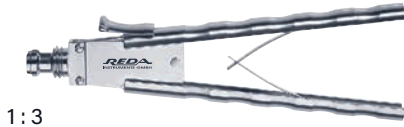

Axial handle, v-shaped type with spreading spring and ratchet

R038 - 000000 - 000

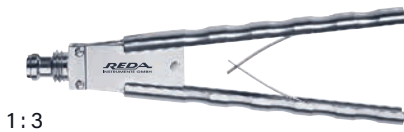

Axial handle, with spreading spring

R048 - 000000 - 000



Axial handle with rings and ratchet

R037 - 000000 - 000



Axial ring handle

R047 - 000000 - 000



Axial handle, v-shaped angled, type with spreading spring and ratchet

R039 - 000000 - 000



Axial handle, angled, with spreading spring

R040 - 000000 - 000

Carbon Handles

more details at the beginning of the chapter

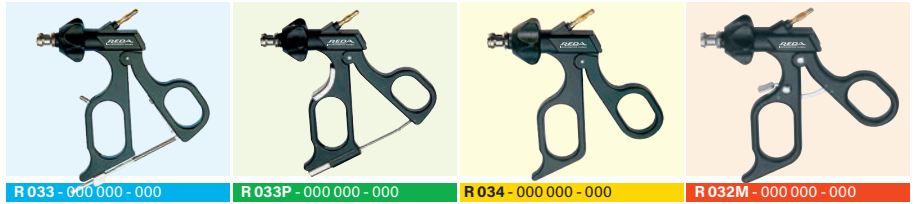

Ø 3 mm

R 033 - 000 000 - 000

R 033P - 000 000 - 000

R 034 - 000 000 - 000

R 032M - 000 000 - 000



Universal grasping forceps, straight, double action jaws

Working length	Working insert alone	Complete instrument			
180 mm	R100-030180-210	R103-030180-210	R103P-030180-210	R104-030180-210	R102M-030180-210
210 mm	R100-030210-210	R103-030210-210	R103P-030210-210	R104-030210-210	R102M-030210-210
330 mm	R100-030330-210	R103-030330-210	R103P-030330-210	R104-030330-210	R102M-030330-210



MARYLAND grasping forceps, curved, double action jaws

Working length	Working insert alone	Complete instrument			
180 mm	R100-030180-212	R103-030180-212	R103P-030180-212	R104-030180-212	R102M-030180-212
210 mm	R100-030210-212	R103-030210-212	R103P-030210-212	R104-030210-212	R102M-030210-212
330 mm	R100-030330-212	R103-030330-212	R103P-030330-212	R104-030330-212	R102M-030330-212



Dissections forceps, fenestrated, oval, double action jaws

Working length	Working insert alone	Complete instrument			
180 mm	R100-030180-214	R103-030180-214	R103P-030180-214	R104-030180-214	R102M-030180-214
210 mm	R100-030210-214	R103-030210-214	R103P-030210-214	R104-030210-214	R102M-030210-214
330 mm	R100-030330-214	R103-030330-214	R103P-030330-214	R104-030330-214	R102M-030330-214



Grasping forceps with reservoir, tip blunt, double action jaws

Working length	Working insert alone	Complete instrument			
180 mm	R100-030180-220	R103-030180-220	R103P-030180-220	R104-030180-220	R102M-030180-220
210 mm	R100-030210-220	R103-030210-220	R103P-030210-220	R104-030210-220	R102M-030210-220
330 mm	R100-030330-220	R103-030330-220	R103P-030330-220	R104-030330-220	R102M-030330-220

Stainless steel Handles

more details at the beginning of the chapter



R 037 - 000 000 - 000

R 038 - 000 000 - 000

Ø 3 mm



Universal grasping forceps, straight, double action jaws

Working length

Complete instrument		mm
R107-030180-210	R108-030180-210	180
R107-030210-210	R108-030210-210	210
R107-030330-210	R108-030330-210	330



MARYLAND grasping forceps, curved, double action jaws

Working length

Complete instrument		mm
R107-030180-212	R108-030180-212	180
R107-030210-212	R108-030210-212	210
R107-030330-212	R108-030330-212	330



Dissections forceps, fenestrated, oval, double action jaws

Working length

Complete instrument		mm
R107-030180-214	R108-030180-214	180
R107-030210-214	R108-030210-214	210
R107-030330-214	R108-030330-214	330



Grasping forceps with reservoir, tip blunt, double action jaws

Working length

Complete instrument		mm
R107-030180-220	R108-030180-220	180
R107-030210-220	R108-030210-220	210
R107-030330-220	R108-030330-220	330

Carbon Handles

more details at the beginning of the chapter



Ø 3 mm

R 033 - 000 000 - 000

R 033P - 000 000 - 000

R 034 - 000 000 - 000

R 032M - 000 000 - 000



Grasping forceps with reservoir, tip conical, double action jaws

Working length	Working insert alone	Complete instrument			
180 mm	R100-030180-222	R103-030180-222	R103P-030180-222	R104-030180-222	R102M-030180-222
210 mm	R100-030210-222	R103-030210-222	R103P-030210-222	R104-030210-222	R102M-030210-222
330 mm	R100-030330-222	R103-030330-222	R103P-030330-222	R104-030330-222	R102M-030330-222



Delphin grasping forceps with reservoir, double action jaws

Working length	Working insert alone	Complete instrument			
180 mm	R100-030180-224	R103-030180-224	R103P-030180-224	R104-030180-224	R102M-030180-224
210 mm	R100-030210-224	R103-030210-224	R103P-030210-224	R104-030210-224	R102M-030210-224
330 mm	R100-030330-224	R103-030330-224	R103P-030330-224	R104-030330-224	R102M-030330-224



Grasping forceps, crosswise teeth, jaw length 14 mm, conical, double action jaws

Working length	Working insert alone	Complete instrument			
180 mm	R100-030180-230	R103-030180-230	R103P-030180-230	R104-030180-230	R102M-030180-230
210 mm	R100-030210-230	R103-030210-230	R103P-030210-230	R104-030210-230	R102M-030210-230
330 mm	R100-030330-230	R103-030330-230	R103P-030330-230	R104-030330-230	R102M-030330-230



Claw grasping forceps, 3 x 2 teeth, single action jaws

Working length	Working insert alone	Complete instrument			
180 mm	R100-030180-242	R103-030180-242	R103P-030180-242	R104-030180-242	R102M-030180-242
210 mm	R100-030210-242	R103-030210-242	R103P-030210-242	R104-030210-242	R102M-030210-242
330 mm	R100-030330-242	R103-030330-242	R103P-030330-242	R104-030330-242	R102M-030330-242

Stainless steel Handles

more details at the beginning of the chapter



R 037 - 000 000 - 000

R 038 - 000 000 - 000

Ø 3 mm



Grasping forceps with reservoir, tip conical, double action jaws

Working length

Complete instrument		mm
R107-030180-222	R108-030180-222	180
R107-030210-222	R108-030210-222	210
R107-030330-222	R108-030330-222	330



Delphin grasping forceps with reservoir, double action jaws

Working length

Complete instrument		mm
R107-030180-224	R108-030180-224	180
R107-030210-224	R108-030210-224	210
R107-030330-224	R108-030330-224	330



Grasping forceps, crosswise teeth, jaw length 14 mm, conical, double action jaws

Working length

Complete instrument		mm
R107-030180-230	R108-030180-230	180
R107-030210-230	R108-030210-230	210
R107-030330-230	R108-030330-230	330



Claw grasping forceps, 3 x 2 teeth, single action jaws

Working length

Complete instrument		mm
R107-030180-242	R108-030180-242	180
R107-030210-242	R108-030210-242	210
R107-030330-242	R108-030330-242	330

Carbon Handles

more details at the beginning of the chapter

Stainless steel Handles

more details at the beginning of the chapter



Ø 3 mm



METZENBAUM scissors, straight, double action jaws

Working length	Working insert alone	Complete instrument		
180 mm	R100-030180-110	R104-030180-110	R147-030180-110	R148-030180-110
210 mm	R100-030210-110	R104-030210-110	R147-030210-110	R148-030210-110
330 mm	R100-030330-110	R104-030330-110	R147-030330-110	R148-030330-110



METZENBAUM scissors, curved, double action jaws

Working length	Working insert alone	Complete instrument		
180 mm	R100-030180-112	R104-030180-112	R147-030180-112	R148-030180-112
210 mm	R100-030210-112	R104-030210-112	R147-030210-112	R148-030210-112
330 mm	R100-030330-112	R104-030330-112	R147-030330-112	R148-030330-112



Peritoneal scissors, serrated, straight, single action jaws

Working length	Working insert alone	Complete instrument		
180 mm	R100-030180-114	R104-030180-114	R147-030180-114	R148-030180-114
210 mm	R100-030210-114	R104-030210-114	R147-030210-114	R148-030210-114
330 mm	R100-030330-114	R104-030330-114	R147-030330-114	R148-030330-114

Carbon Handles

more details at the beginning of the chapter

Stainless steel Handles

more details at the beginning of the chapter



Ø 3 mm



Hook scissors, straight, single action jaws

Working length	Working insert alone	Complete instrument		
180 mm	R100-030180-116	R104-030180-116	R147-030180-116	R148-030180-116
210 mm	R100-030210-116	R104-030210-116	R147-030210-116	R148-030210-116
330 mm	R100-030330-116	R104-030330-116	R147-030330-116	R148-030330-116



Micro scissors, straight, single action jaws

Working length	Working insert alone	Complete instrument		
180 mm	R100-030180-118	R104-030180-118	R147-030180-118	R148-030180-118
210 mm	R100-030210-118	R104-030210-118	R147-030210-118	R148-030210-118
330 mm	R100-030330-118	R104-030330-118	R147-030330-118	R148-030330-118

Carbon Handles

more details at the beginning of the chapter



R 034 - 000 000 - 000

Ø 3 mm



Biopsy cup, sharp, without thorn, double action jaws

Working length	Working insert alone	Complete instrument
180 mm	R100-030180-310	R104-030180-310
210 mm	R100-030210-310	R104-030210-310
330 mm	R100-030330-310	R104-030330-310



Biopsy cup, sharp, with thorn, double action jaws

Working length	Working insert alone	Complete instrument
180 mm	R100-030180-312	R104-030180-312
210 mm	R100-030210-312	R104-030210-312
330 mm	R100-030330-312	R104-030330-312



INSTRUMENTE GMBH

Ø 3 mm

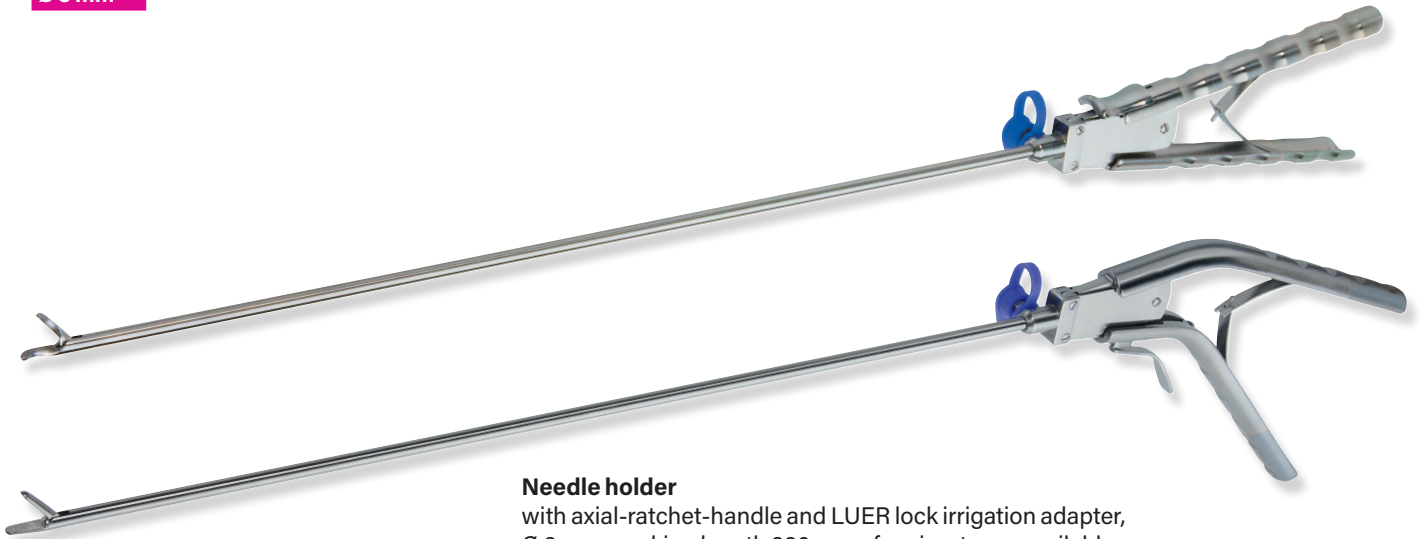

Needle holder
with axial-ratchet-handle and LUER lock irrigation adapter,
Ø 3 mm, working length 330 mm - four jaw types available.



Needle holder, straight,
with inserted tungsten carbide, crosswise teeth, single action jaws

Handle	straight	angled
	R158-0533-350	R159-0533-350



Needle holder, curved left,
with inserted tungsten carbide, crosswise teeth, single action jaws

Handle	straight	angled
	R158-0533-352	R159-0533-352



Needle holder, curved right,
with inserted tungsten carbide, crosswise teeth, single action jaws

Handle	straight	angled
	R158-0533-354	R159-0533-354



Needle holder/-positioner, convex/concave shaped jaws, with fixation teeth,
straight, with wolfram-carbide-coated tips, single action jaws

Handle	straight	angled
	R158-0533-360	R159-0533-360

Carbon Handles

more details at the beginning of the chapter



Ø 3 mm

R 033 - 000 000 - 000

R 033P - 000 000 - 000

R 032M - 000 000 - 000



Needleholder with inserted tungsten carbide, straight, single action jaws

Working length	Working insert alone	Complete instrument		
210 mm	R150-030210-350	R153-030210-350	R153P-030210-350	R151-030210-350
330 mm	R150-030330-350	R153-030330-350	R153P-030330-350	R151-030330-350



Needleholder with inserted tungsten carbide, curved left, single action jaws

Working length	Working insert alone	Complete instrument		
210 mm	R150-030210-352	R153-030210-352	R153P-030210-352	R151-030210-352
330 mm	R150-030330-352	R153-030330-352	R153P-030330-352	R151-030330-352



Needleholder with inserted tungsten carbide, curved right, single action jaws

Working length	Working insert alone	Complete instrument		
210 mm	R150-030210-354	R153-030210-354	R153P-030210-354	R151-030210-354
330 mm	R150-030330-354	R153-030330-354	R153P-030330-354	R151-030330-354



Needleholder/-positioner insert, convex/concave with teeth, TC

Working length	Working insert alone	Complete instrument		
210 mm	R150-030210-360	R153-030210-360	R153P-030210-360	R151-030210-360
330 mm	R150-030330-360	R153-030330-360	R153P-030330-360	R151-030330-360

Stainless steel Handles
more details at the beginning of the chapter



Ø 3 mm



Needleholder with inserted tungsten carbide, straight, single action jaws

Complete instrument			Working length mm
R157-030210-350	R158-030210-350	R159-030210-350	210
R157-030330-350	R158-030330-350	R159-030330-350	330



Needleholder with inserted tungsten carbide, curved left, single action jaws

Complete instrument			Working length mm
R157-030210-352	R158-030210-352	R159-030210-352	210
R157-030330-352	R158-030330-352	R159-030330-352	330



Needleholder with inserted tungsten carbide, curved right, single action jaws

Complete instrument			Working length mm
R157-030210-354	R158-030210-354	R159-030210-354	210
R157-030330-354	R158-030330-354	R159-030330-354	330







Needleholder/-positioner insert, convex/concave with teeth, TC

Complete instrument			Working length mm
R157-030210-360	R158-030210-360	R159-030210-360	210
R157-030330-360	R158-030330-360	R159-030330-360	330

Ø 2,8 mm

Monopolar electrode with small handle,
Ø 2,8 mm



	Type	working length	
		330 mm	250 mm
	Button type electrode	R060-028330-001	R060-028250-001
	J-hook electrode	R060-028330-002	R060-028250-002
	L-hook electrode	R060-028330-003	R060-028250-003
	Spatula electrode	R060-028330-004	R060-028250-004
	Needle electrode	R060-028330-005	R060-028250-005

Ø 2,8 mm

Palpation probe
Ø 2,8 mm



working length

330 mm	R090-028330-001
250 mm	R090-028250-001

Ø 2,8 mm

Suction-Irrigation-Cannula
with Tube Connection
roundhole Sucker with 8 drillings

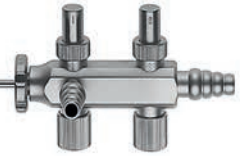

working length complete with handle

330 mm R071-028330-008

250 mm R071-028250-008

Handle with trumpet valve

R071-000000-000

working length roundhole Sucker with 8 drillings

330 mm R070-028330-008

250 mm R070-028250-008

Suction-Irrigation-Cannula
with sliding valves
and tube with 8 drillings



working length complete with handle

330 mm R072-028330-008

250 mm R072-028250-008

Handle with sliding valve

R072-000000-000

working length roundhole Sucker with 8 drillings

330 mm R070-028330-008

250 mm R070-028250-008

Ø 2,8 mm

Suction-Irrigation-Cannula
with trumpet valves
and Square Handle



working length

330 mm	R075-028330-016
250 mm	R075-028250-016

Ø 1,2 mm

Puncture- and Injection Needle
distal with needle,
proximal with LL-adapter



working length Nadel / Needle

330 mm	R075-028330-012
250 mm	R075-028250-012

Valve with Adapter for Tubes
with large Luer-Lock-Connection

Suction-Irrigation-Handle
with sliding valve and turnable
adapter for large Luer-Lock
Tube connection
two combined Luer-Lock /
Tube Connectors

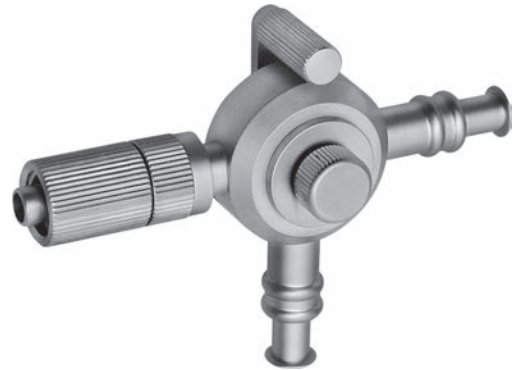

R076-000000-300

Ø 3,0 mm

Exchangeable Suction-Irrigation-Tube
with large Luer-Lock-Connection



working length 4 sidewise drillings

340 mm R070-030340-304

working length 16 sidewise drillings

340 mm R070-030340-316

Ø 3,5 mm

Suction-Irrigation-Handle

with color-coding

- **20% less weight**
- **less individual parts**
- **color-coding**
blue - irrigation
green - suction
- **two in one**
sidewise Tube-Luer-Lock-Connection



Suction-Irrigation-Handle 10 mm

with large Tube-Connection and sidewise Tube-Luer-Lock-Connection

R078-000000-100

working length **Tube for 10 mm Suction-Irrigation-Handle, Ø 3,5 mm**

240 mm R070-035240-116

Ø 3 mm

1 Handle
2 Functions

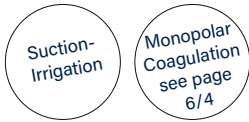

Suction-Irrigation-Handle

with two-way sliding valve and tube connections

- **ergonomic handle design**
- **enlarged suction channel**
- **straight passages for suction-irrigation liquid**
- **comfortable operation due to short swivel movement of the valve**

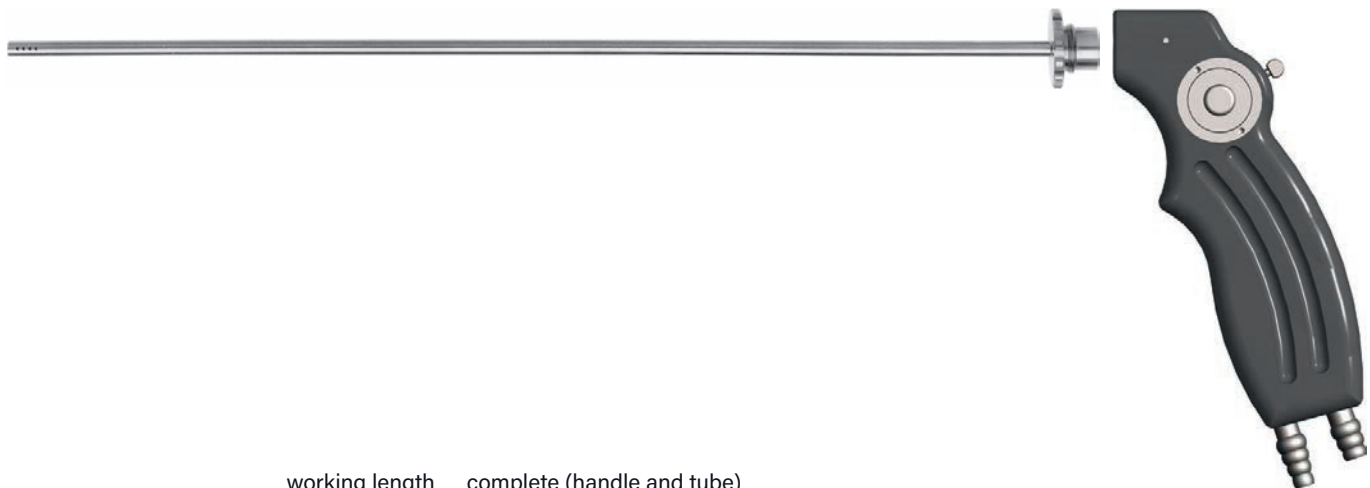

working length complete (handle and tube)

330 mm R079-030330-416

Handle with sliding valve

R064-050000-001

Tube only Ø 3,0 mm

R070-030330-416

Valve Handle for Shaft M8 x 1

Suction-Irrigation-Handle
with Trumpet Valve

for exchangeable shafts with threads M8 x 1
combined Luer-Lock / Tube connector



R076-000000-200

Suction-Irrigation-Pistol-Handle
with Sliding Valve

for exchangeable shafts with threads M8 x 1
two combined Luer-Lock / Tube connector



R079-000000-200

Ø 3,0 mm

Exchangeable Suction-Irrigation-Tube
with threads M8 x 1



working length 4 side drill holes

340 mm R070-030340-204

working length 16 side drill holes

340 mm R070-030340-216

Ø 10 mm

Thoracoscope with integrated fiberoptic
for illumination, autoclavable



diameter	working length	direction of view
Ø 10,0 mm	180 mm	30° R110-100178-030

Ø 6 / 11 / 13 mm

Thorax trocar sleeve rigid,
metal tube with thread



diameter	working length	Trocar sleeve only	Obturator only
Ø 6 mm	50 mm	R111-060050-006	R111-060050-003
Ø 11 mm	50 mm	R111-110050-006	R111-110050-003
Ø 13 mm	50 mm	R111-130050-006	R111-130050-003

Thorax trocar sleeve flexible,
plastic tube with thread, exchangeable

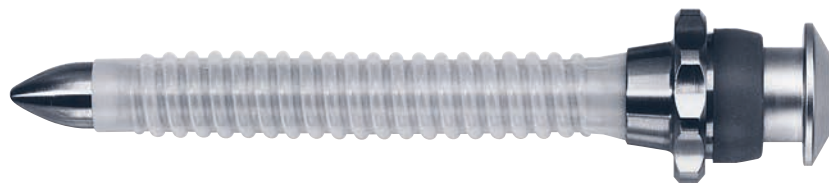

diameter	working length	Trocar sleeve only	Obturator only	flexible silicon tubes 5 pcs. /pack
Ø 6 mm	100 mm	R112-060100-006	R112-060100-003	R112-060100-606
Ø 6 mm	70 mm	R112-060070-006	R112-060070-003	R112-060070-606
Ø 11 mm	100 mm	R112-110100-006	R112-110100-003	R112-110100-606
Ø 11 mm	70 mm	R112-110070-006	R112-110070-003	R112-110070-606

DENNIS dissector

Working length: 9" (23 cm)

Total length: 13 1/4" (33.5 cm)



Serrated jaws

7 mm shaft



R119-93527-04

Working length: 9 1/2" (24 cm)
Total length: 13 1/4" (33.5 cm)



sliding shaft
10 mm, straight

R119-93527-17



sliding shaft
slim 7 mm, curved

R119-93527-16

sliding shaft
regular 10 mm, curved

R119-93527-01

ALLIS forceps

Working length: 9" (23 cm)

Total length: 13 1/4" (33.5 cm)

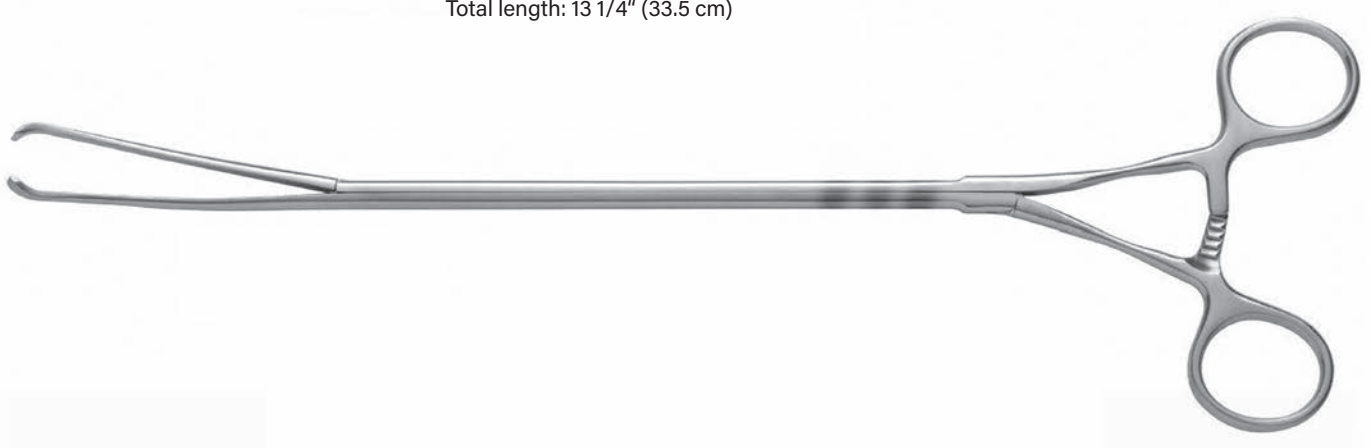

6 mm width jaws

7 mm shaft



R119-93527-13

STERN chest tube passer

Working length: 6 7/8" (17,5 cm)

Total length: 9 3/4" (24,8 cm)



without ratchet
10 mm shaft

R119-93527-21

STERN chest tube passer

Working length: 11" (28 cm)

Total length: 14" (35,6 cm)



with ratchet
10 mm shaft

R119-93527-18

without ratchet
10 mm shaft

R119-93527-19

DEBAKEY COOLEY forceps

Working length: 9 1/2" (24 cm)

Total length: 13 1/2" (34 cm)



without ratchet
DeBakey Cooley jaws
10 mm shaft

R119-93527-06

with ratchet
DeBakey Cooley jaws
10 mm shaft

R119-93527-10

HARKEN clamps

Working length: 9 7/8" (24.8 cm)

Total length: 14" (35.5 cm)



without ratchet
HARKEN #1
DEBAKEY jaws
10 mm shaft



R119-93527-14

without ratchet
HARKEN #2
DEBAKEY jaws
10 mm shaft



R119-93527-15

DEBAKEY clamps

Working length: 10" (25.4 cm)

Total length: 14 1/4" (36 cm)



6.5 cm jaw length
1 x 2 DEBAKEY jaws
10 mm shaft

R119-93527-05



10 cm jaw length
1 x 2 DEBAKEY jaws
10 mm shaft

R119-93527-12



10 cm jaw length
2 x 3 DEBAKEY jaws
10 mm shaft

R119-93527-11

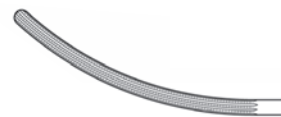

Needle Holders for 2-0 Suture

Working length: 8 1/4" (21 cm)

Total length: 13 1/2" (34 cm)

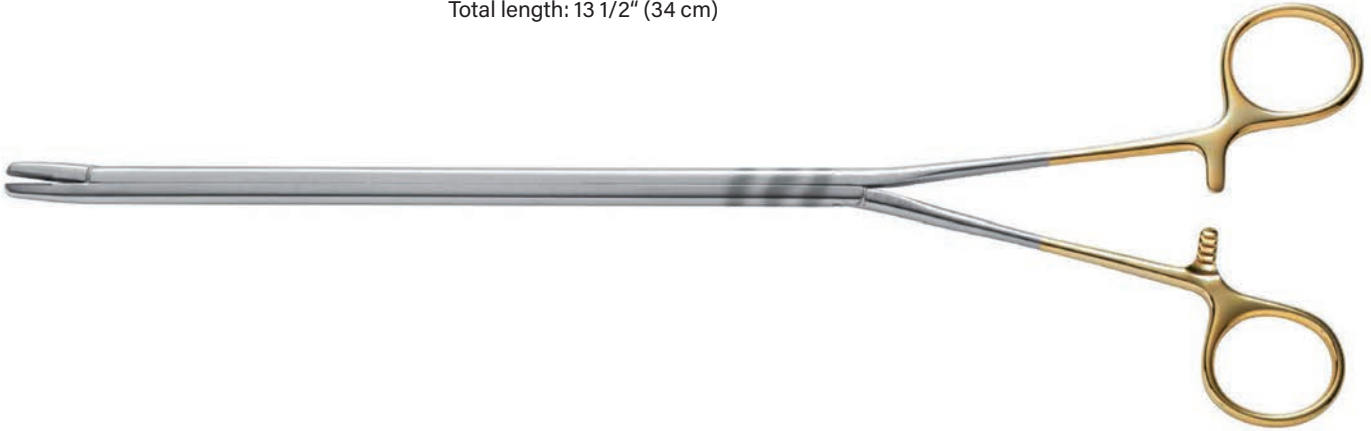

2-0 and smaller suture
Straight, Carbon-inlay jaws
10 mm shaft

R119-93527-07



2-0 and smaller suture
Curved, Carbon-inlay jaws
10 mm shaft

R119-93527-08

DUVAL clamps

Working length: 9 1/4" (23.5 cm)

Total length: 13 1/2" (34 cm)





DUVAL clamp
2.5 cm width jaws
10 mm shaft

R119-93527-20

Ø 5,0 mm

Monopolar thoracic electrode,
30° curved, HF-connector Ø 4 mm male



	type	working length
	Ø 5 mm	330 mm
	L-hook electrode	R116-050330-003
	Spatula electrode	R116-050330-004

Monopolar thoracic electrode,
30° curved, with suction/irrigation channel, Electrode assembly alone without handle



	type	working length
	Ø 5 mm	330 mm
	L-hook electrode	R116-050330-103

Handles see next page

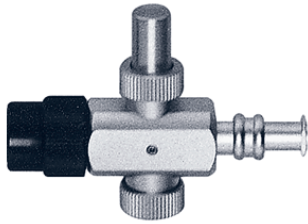

Suction-irrigation handle

1 trumpet valve with LL-adaptor

R118-000000-500



Suction-irrigation handle

2-way-valves

R117-000000-500

Ø 5 mm

Suction-irrigation tube

Ø 5 mm with distal 4x1 hole, 30° curved, working length 330 mm

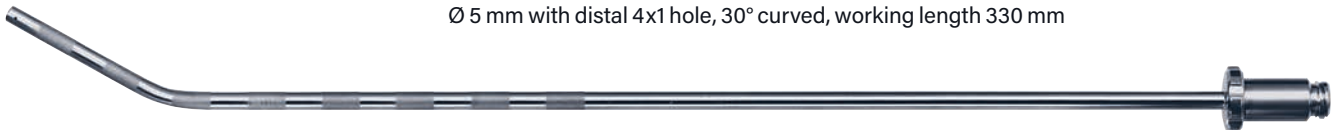

R117-050330-504

Injection needle

Ø 5 mm, 30° curved, working length 330 mm

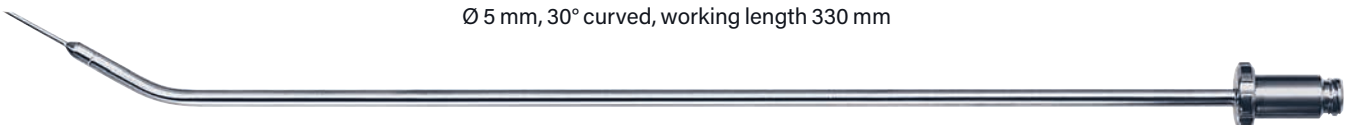

R117-050330-501



INSTRUMENTE GMBH

Hysteroscopes

with integrated fiberoptic for illumination, autoclavable



Compatibility

Light port adapter	ACMI-, Wolf-, Storz / Olympus
Eyepiece	Ocular according DIN 58105 threaded
Objective	Tension-free objective composed-objective
Image transmission	CAD-designed rodence system for optimal sharpness, colorsync and resolution
Light-guiding system	High quality light fibers
Optical glass	Distal and proximal Sapphire
Biocompatibility	All materials that come in contact with the body are biocompatible. All outside metal parts are made of high quality stainless steel.

Ø	working length	direction of view	
		0°	30°
4,0 mm	302 mm	R300-040302-000	R300-040302-030

Ø 7,0 mm

Multi function valve trocar sleeve,
metal sleeve, smooth



working length

95 mm R023-070095-001

Standard trocar



working length pyramidal

95 mm R020-070095-001



working length conical

95 mm R020-070095-002

Diagnostic Sheaths
For Scope Ø 2,7 mm
Outer Ø 4,0 mm

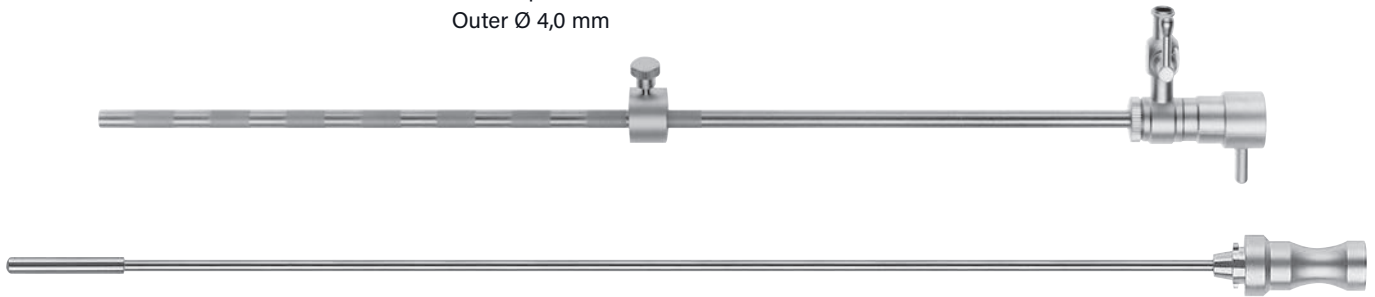

	Stopcock, fixed		Stopcock, rotating
working length	0° with Distance-Holder		working length
281 mm	R210-040281-000		274 mm R211-040281-000
	30° complete with Obturator and Distance-Holder		
281 mm	R210-040281-130		274 mm R211-040281-130
	30° with Distance-Holder		
281 mm	R210-040281-030		274 mm R211-040281-030
	Obturator only		
	R210-040305-00		
	Distance-Holder only		
	R210-040306-00		

Diagnostic Sheaths
For Scope Ø 4,0 mm
Outer Ø 5,0 mm

	Stopcock, fixed		Stopcock, rotating
working length	0° complete with Obturator and Distance-Holder		working length
281 mm	R210-050281-001		274 mm R211-050274-001
	0° with Distance-Holder		
281 mm	R210-050274-000		274 mm R211-050274-000
	30° complete with Obturator and Distance-Holder		
281 mm	R210-050274-130		274 mm R211-050274-130
	30° with Distance-Holder		
281 mm	R210-050274-030		274 mm R211-050274-030
	Obturator only		
	R210-050305-00		
	Distance-Holder only		
	R210-050306-00		

Operation Sheaths with 1 Working Channel

For Scope Ø 4,0 mm

Outer Ø 7,5 mm



working length	working channel	Sheath with 1 rotating stopcock	Sheath with 2 rotating stopcocks
211 mm	7 CH.	30° OP - Sheath R211-075211-030	R212-075211-030

Continuous-Flow-Sheaths

For Scope Ø 2,7 mm

Outer Ø 6,0

These sheaths have a separate Irrigation- and Working Channel.

The Outer Tube is detachable.



Sheath complete with 2 separate rotating stopcocks

working length	working channel	0° Continuous-Flow-Sheath
193 mm	5 CH.	R214-060193-000
		30° Continuous-Flow-Sheath
193 mm	5 CH.	R214-060193-030

Continuous-Flow-Sheaths

For Scope Ø 4,0 mm

Outer Ø 8,0 mm

Sheath complete with 2 separate rotating stopcocks

working length	working channel	0° Continuous-Flow-Sheath
193 mm	7 CH.	R214-080193-000
		30° Continuous-Flow-Sheath
193 mm	7 CH.	R214-080193-030

Continuous-Flow Operating Sheaths
for Hysteroscopes Ø 2,7 mm and Ø 2,9 mm



Diagnostic-Continuous-Flow-Inner Sheath, 1 stopcock, rigid

working length	0° - 300 mm	Outer Ø
260 mm	R213-037260-000	4,0
	30° - 300 mm	
260 mm	R213-037260-030	4,0



Diagnostic-Continuous-Flow-Outer Sheath, 1 stopcock, rigid

working length	0°, 30° - 300 mm, suitable for R213-037260-000, R213-037260-030	Outer Ø
240 mm	R213-050260-000	5,0



Obturator

suitable for R213-050260-000

R213-050300-000

Continuous-Flow Operating Sheaths
for Hysteroscopes Ø 2,7 mm and Ø 2,9 mm



working length	working channel	1 Instrument Port
228 mm	5 CH.	R212-038300-000

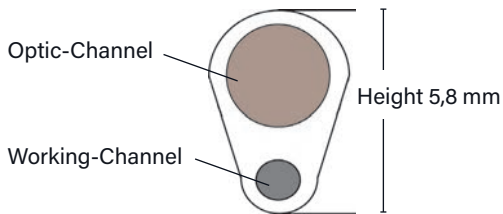

working length	Diagnostic-Continuous-Flow-Outer Sheath, 1 stopcock, rigid
215 mm	R212-040300-000

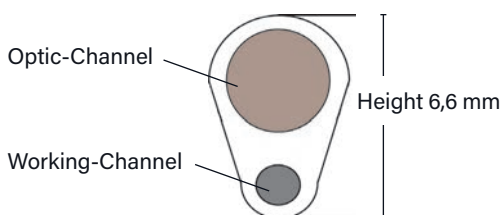

Hysteroscopy - Operating Sheaths
for Hysteroscopes Ø 2,7 mm and Ø 2,9 mm



1 Instrument Port, 2 stopcock, rigid

working length	working channel	30° - 300 mm
222 mm	5 CH.	R212-035248-101

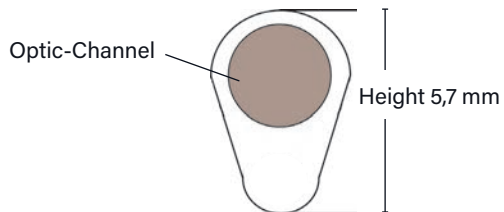

Continuous-Flow Operating Sheaths
for Hysteroscopes Ø 4,0 mm



Diagnostic-Continuous-Flow-Inner Sheath, 1 stopcock, rigid		
working length		Outer Ø
0° - 300 mm		5,3
260 mm	R213-054260-000	
30° - 300 mm		5,3
260 mm	R213-054260-030	



Diagnostic-Continuous-Flow-Outer Sheath, 1 stopcock, rigid		
working length		Outer Ø
0°, 30° - 300 mm, suitable for R213-054260-000, R213-0542600-030		6,5
240 mm	R213-065250-030	



Obturator
suitable for R213-065250-030
R213-065300-000

Continuous-Flow Operating Sheaths
for Hysteroscopes Ø 4,0 mm



1 Instrument Port

working length	working channel	30° - 300 mm	Outer Ø
175 mm	7 CH.	R214-070000-030	5,4

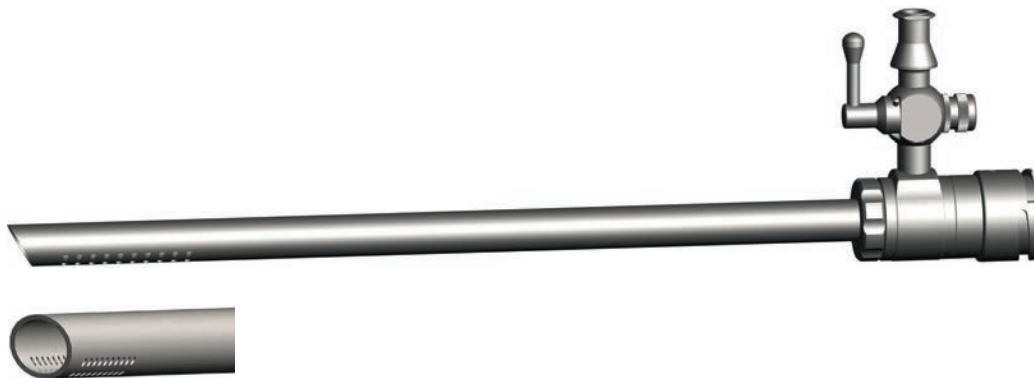

Diagnostic-Continuous-Flow-Outer Sheath, 1 stopcock, rigid

working length	30° - 300 mm, suitable for R214-070000-030	Outer Ø
155 mm	R214-070200-030	7,6



Obturator

suitable for R214-070200-030

R214-070000-000

WL 41 cm

Hysteroscopy Forceps,
semi-rigid



Ø 5 [Char]

Ø 7 [Char]



Grasping Forceps, cup serrated

R292-017400-003



Cutting Biopsy Punch

R292-017400-002

R292-023400-002



PE-Forceps, cup, sharp

R292-017400-001

R292-023400-001



Alligator Forceps

R292-017400-011

R292-023400-011



Scissors, pointed tips

R292-017400-022

R292-023400-022



Grasping Forceps, cup serrated

R292-017400-004

R292-023400-004



Scissors, blunt tips

R292-017400-021

R292-023400-021

Ring Applicator

with advanced handling: more safety for the user due to 3-Positions-System.

Position 0 = **Safety**

Position 1 = 1st ring

Position 2 = 2nd ring

Simplified assembly and disassembly due to **Click**-mechanism on the sliding bar.

Ø 6,0 mm

First Incision

For use with Operating-Laparoscope



working length

327 mm

Complete with Loading Device and Conus suitable for OP-Laparoscope: STANDARD

R120-060330-001



Loading Device

R120-060000-002



Conus Piece

R120-060000-001

Ø 6,5 mm

Second Incision

For use with a regular Trocar Sleeve

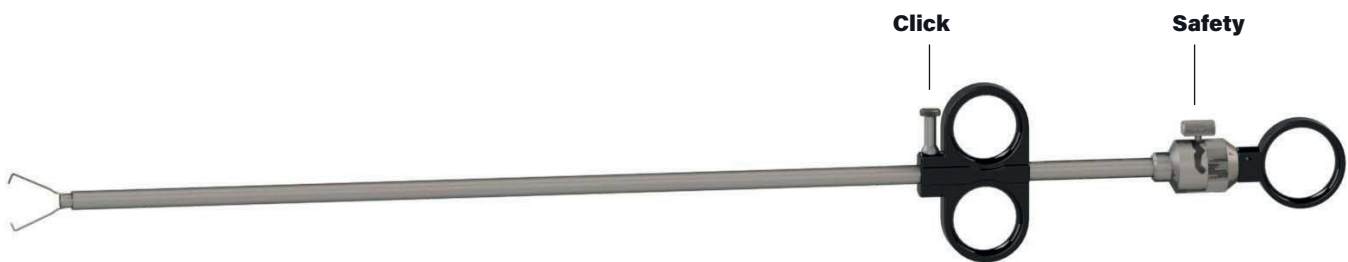

working length

300 mm

Complete with Loading Device

R120-065340-001



Loading Device

R120-060000-002



Conus Piece

R120-060000-001

Ø 5 / 10 mm

Myoma Drill



working length Ø 5,0 mm

330 mm R121-050320-01

Ø 10,0 mm

330 mm R121-100330-01

COHEN Intra Uterine Cannula
with spring-loaded fixation, one large and one small cone



working length Complete

170 mm R122-250170-000

Cone alone, Ø 19 mm, small

R122-190056-000

Cone alone, Ø 25 mm, large

R122-250056-000

Uterine Cannula allone





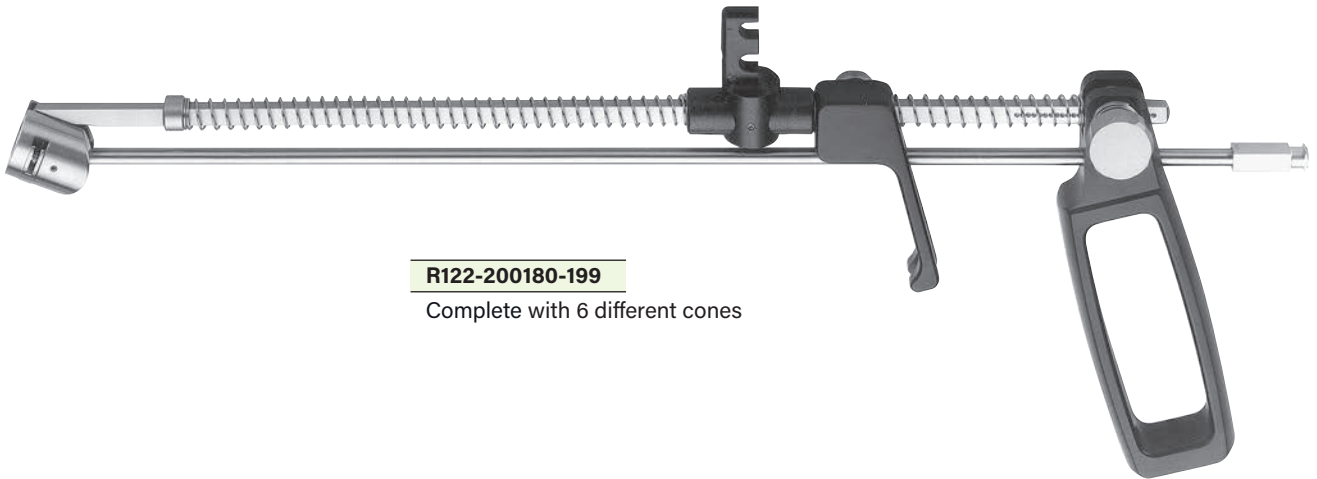

R122-250170-001

Uterus Manipulator



R122-200180-199

Complete with 6 different cones

	working length	Ø	
	45 mm	3 mm	Uterus obturator, thin, short R122-030045-000
	55 mm	3 mm	Uterus obturator, thin, long R122-030055-000
	80 mm	8 mm	Uterus obturator, medium, long R122-080080-000
	100 mm	10 mm	Uterus obturator, thick, extra long R122-100100-000
	60 mm	25 mm	Cone, with short thorn R122-250060-000
	70 mm	25 mm	Cone, with long thorn R122-250070-000
			Manipulator alone, without cones R122-200180-000

Coagulation electrodes, flexible, monopolar
470 mm

Ball end



Ø 5 [Char]

R395-017450-001

Ø 7 [Char]

R395-023450-001

Ø 9 [Char]

R395-030450-001

Needle type



R395-017450-021

R395-023450-021

Loop



R395-023450-011

Bipolar electrodes, flexible
360 mm



Ball end



Ø 5 [Char]

R396-000360-001

Needle type



Ø 5 [Char]

R396-000360-002

Ø 7,0 mm

LOWSLEY retractor

for manipulation of the bladder
for perineal prostatectomy



working length

210 mm R139-070210-001 straight



working length

300 mm R139-070300-011 curved



bonded for Halogen Light	Ø	length cm	fused for Xenon Light
R900-035180-00	3,5	180	R901-035180-00
R900-035230-00	3,5	230	R901-035230-00
R900-035300-00	3,5	300	R901-035300-00
R900-035350-00	3,5	350	R901-035350-00
R900-048180-00	4,8	180	R901-048180-00
R900-048230-00	4,8	230	R901-048230-00
R900-048250-00	4,8	250	R901-048250-00
R900-048300-00	4,8	300	R901-048300-00
R900-048350-00	4,8	350	R901-048350-00

Other lengths available on demand.



IN

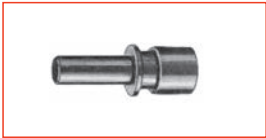

R900-000000-01
Storz / Aesculap

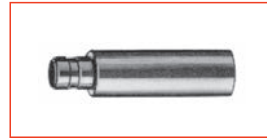

R900-000000-21
MLW

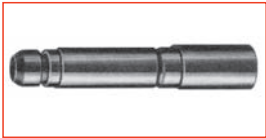

R900-000000-03
Wolf / Henke Sass /
Dyonics / Medicon /
Comeg

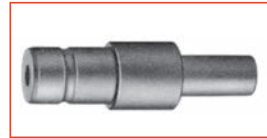

R900-000000-31
Volpi / Schöilly / RFO



R900-000000-05
ACM / British / Codman

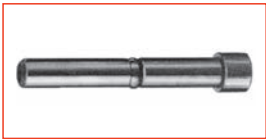

R900-000000-07
Olympus

Endoscope-side



R900-000000-09
Pentax

OUT



R900-000000-11
Fuji



R900-000000-02
Storz / Winter+IBE /
Aesculap



R900-000000-13
Heine-Optotechnik



R900-000000-04
Wolf

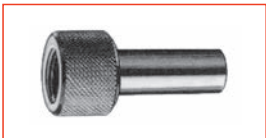

R900-000000-15
Winter+IBE



R900-000000-06
ACM / British / Codman



R900-000000-16
Stryker



R900-000000-08
Olympus

FULL HD-Camera



Full HD-Camera

**What matters today: Full HD resolution,
impressive handling, good economical solution**

- Full HD-Camera
- Integrated LED-Light-Source
- Photo and video documentation in Full HD

What the players in the field of minimally invasive medicine expect today from a camera is the combination of great resolution, natural color reproduction, high quality manufacturing, and the greatest ease of use possible. The Full HD-Camera is the result of all these requirements. It produces sharp, true-color images, and is characterized by a high degree of user-friendliness. The Full HD-Camera provides targeted profiles that enable the diagnosis and treatment of the most important medical applications: laparoscopy, arthroscopy, hysteroscopy and urology.

The 3-in-1 solution, combining camera, light source and HD capturing, means only one device is needed. This saves space in the operating room and relieves budget pressures. Rounding out the benefits of the Full HD-Camera is a contemporary, sophisticated design. The compelling, reliable technology makes the Full HD-Camera the perfect choice for demanding target groups.

We offer services worldwide for the Full HD-Camera.



The right product for
the right market.

Full HD-Camera

The Camera head features an ergonomic design and is ideally suited for all indications. The pre-set application profiles make the camera a plug and play device. The brilliant image quality makes it the perfect camera for the main endoscopic applications. However, the user has the possibility to adjust the image as desired.



LED-Light Source

The LED-Light Source has a universal fiber optic cable receptacle compatible with Storz, Olympus, ACMI, and Wolf light cable adapters. The intensity of the Light Source is adjustable. The light intensity is 1,400 lumens. After an operating time of 10,000 hours, We guarantees a minimum light output of at least 90 %.

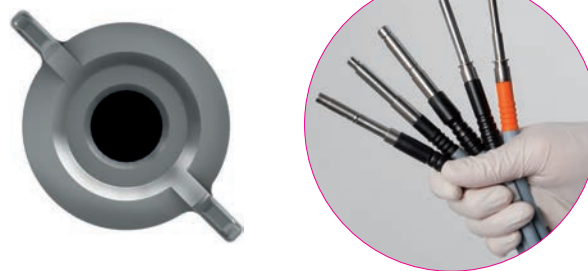

HD-Capturing

The capture unit comes with a USB flash/hard drive interface in which images and videos are recorded in Full HD quality. An external keyboard is used to conveniently input patient data. In addition, every image and video has a time stamp as well as the patient data on it. Through the "New Patient" function it is easy to separate cases and to summarize all videos and photos.



HD-Camera

The one for all cases: high quality, easy to use,
best cost

- HD-Camera
- Integrated LED-Light-Source
- Photo and video documentation in HD

The classic three-in-one HD Camera for cost-sensitive markets in proven quality. New customer demands require new solutions. In fast growing markets, device costs can be adjusted flexibly to the individual circumstances of the hospital or doctor's practice.

The new HD-Camera does exactly this. It is suitable for the fields of laparoscopy, arthroscopy, hysteroscopy and urology. The three-in-one solution: HD-Camera, LED-Light Source and HD-Capturing are available in one device. The HD-Camera, however, is still user friendly and intuitive to use. The picture quality is brilliant.

The device is approved worldwide and service is available globally.



Three connections for three devices in one, easily aligned for quick set up.

HD-Camera

The Camera head features an ergonomic design and is ideally suited for all indications. The pre-set application profiles make the camera a plug and play device. The brilliant image quality makes it the perfect camera for the main endoscopic applications. However, the user has the possibility to adjust the image as desired.



LED-Light Source

The LED-Light Source has a universal fiber optic cable receptacle compatible with Storz, Olympus, ACMI, and Wolf light cable adapters. The intensity of the Light Source is adjustable. The light intensity is 1,400 lumens. After an operating time of 10,000 hours, We guarantees a minimum light output of at least 90 %.

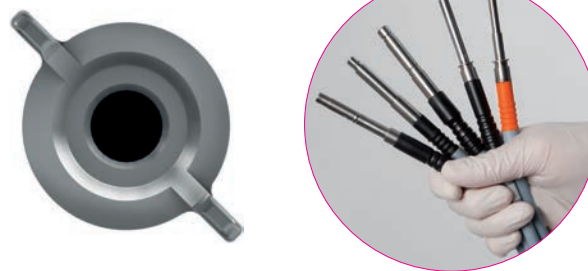

HD-Capturing

An SD storage card interface is available when selecting the capture option to record camera and video images. Photos and videos are saved in HD quality. The amount of memory needed and the speed of saving the data are reduced with an optimal image quality.



Zoom coupler

- Focal length: 16-34 mm
- Image size from circular to full size
- C-Mount camera connection
- Sterilization methods: autoclavation



Keyboard

- Medical keyboard (english)
for patient data input
- Housing material: Silicon
- Interface: PS/2
- Color: grey



HD-Capturing

- Autoclavable
- Flexible
- Light weighted
- Bend protected



Accessories

Devices

Item No.	Description
RHDC1100-L04	Full HD-Camera Head
RHDC1100-L01	Full HD-Camera Control Unit, LED-Light Source, HD-Capturing
RHDC1000-L04	HD-Camera Head
RHDC1000-L01	HD-Camera Control Unit, LED-Light Source, HD-Capturing

Accessories

Part No.	Description
RZOOM-L01	Videocoupler Zoom, Focal length = 16-34 mm (LAP, ARTHRO, HYS, URO, ENT), autoclavable
RURO-L01	URO-Videocoupler 18 mm, 90°
RKeyboard-L01	Medical Keyboard (EN)
R900-000000-07	Adapter for light cable, Light Source, Olympus
R900-000000-01	Adapter for light cable, Light Source, Storz
R900-000000-03	Adapter for light cable, Light Source, Wolf
R900-000000-02	Adapter for light cable, endoscope, Storz/Olympus
R900-000000-04	Adapter for light cable, endoscope, Wolf
R900-000000-06	Adapter for light cable, endoscope, ACMI
R900-048180-00	Light cable, 1.8 m, Ø 4.8 mm
R900-048230-00	Light cable, 2.3 m, Ø 4.8 mm
R900-048300-00	Light cable, 3.0 m, Ø 4.8 mm

Power supply cord and further accessories available upon request.

Technical Data	Full HD-Camera	HD-Camera
Frame rate	60 Hz	60 Hz
Image sensor	1/3" CMOS-Chip	1/3" CMOS-Chip
Resolution (h x v)	1920 x 1080 pixels, output	1280 x 720 pixels, output
Dimensions	Ø = 39,5 mm, L = 123,5 mm	Ø = 39,5 mm, L = 123,5 mm
Weight	300 g/10,5 oz (incl. cable)	300 g/10,5 oz (incl. cable)
Coupling mechanism	C-mount	C-mount
Cable length	3 m/9,8 ft	3 m/9,8 ft
Disinfection/Sterilization	Soakable, STERRAD®	Soakable, STERRAD®
Power supply	100-240 V~	100-240 V~
Power consumption	148 VA	148 VA
Outputs	HDMI, DVI for Full HD, S-Video for ext. capture/printers, PC interface USB 2.0, PS/2, Remote	2x HDMI, PC interface USB 2.0, PS/2, Remote
LED-Light Source		
Lamp	LED	LED
Color temperature	6.500 K	6.500 K
Lumen maintenance	90 % after 10,000 hours	90 % after 10,000 hours
Size	Optimized for light guides 4,8 mm	Optimized for light guides Ø 4,8 mm
Adapter compatibility	Storz, Olympus, Wolf, ACMI	Storz, Olympus, Wolf, ACMI
HD-Capturing		
Memory interface	Records to USB fl ash drive and/ or external USB hard drive	SD memory card
Image format	JPEG	JPEG
Video Codec	MPEG-4, H.264	MPEG-4, H.264
Resolution	1920 x 1080 pixels	1920 x 1080 pixels
Complete system		
Operating conditions	10-40 °C/50-104 °F	10-40 °C/50-104 °F
Protection against electrical shock	Body Float	Body Float
Video Codec Means of protection against electrical shock	Class I	Class I
Dimensions (w x h x d)	381 x 149 x 379 mm	381 x 149 x 379 mm
Weight	5,8 kg	5,8 kg

HD CAMERAs

Classic Line

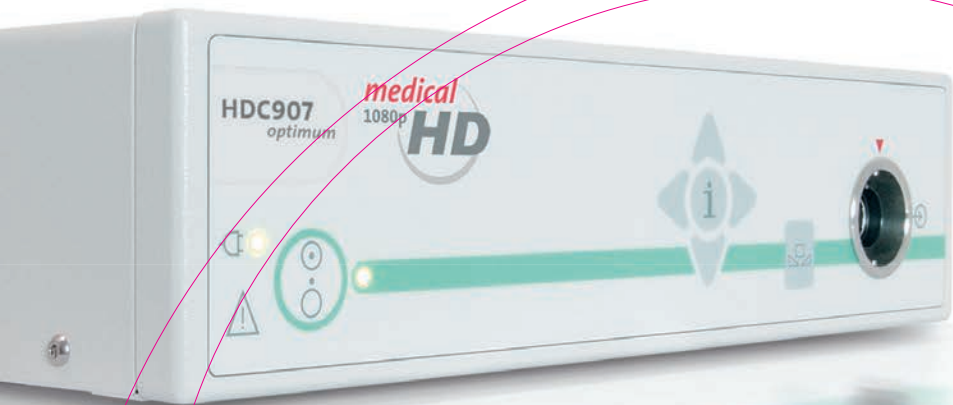

autoclavable

Choose your HD format

In terms of image resolution High Definition video technology has been established in the field of Minimally Invasive Surgery. The switch from the classic 5:4 monitor format to the latest 16:9 or 16:10 widescreen monitors is ongoing. Thus customers find different HD video formats on the market, each with individual benefits and pitfalls for endoscopic imaging. The Cameras offer all formats, so users are free to select their personally preferred format.

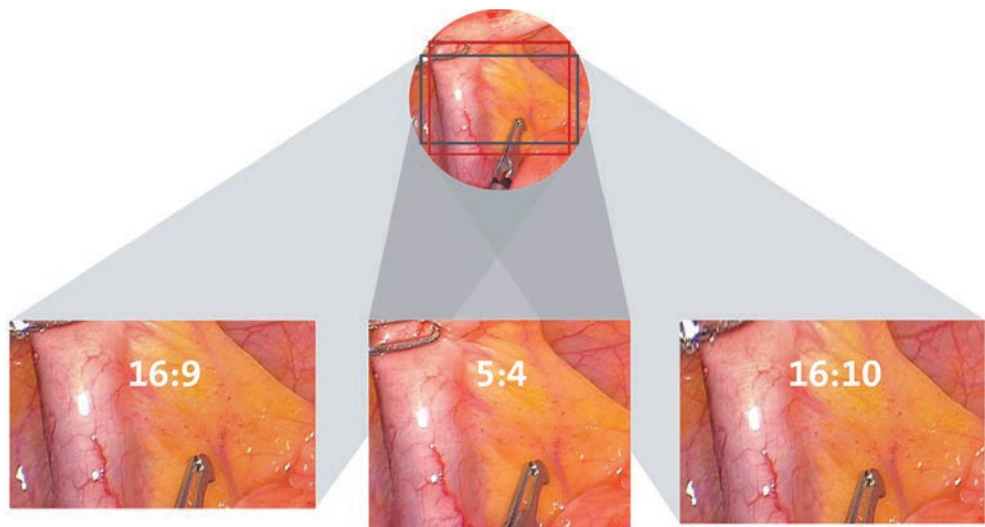

1080p/1080i

1920 x 1080 pixels

16:9 - format with the highest impact on the video market HD video standards 1080p and 1080i

SXGA

1280 x 1024 pixels

5:4 - the ideal video format for Minimally Invasive Surgery

WUXGA

1920 x 1200 pixels

16:10 - optimum format for latest medical grade monitors HD video standard WUXGA (1920 x 1200 pixels)



Further information: www.Medical-HD.com

Video modes

The HDC907optimum supports 1080i and 1080p.

Progressive scan (p) is a method transmitting moving images in which all the lines of each frame are drawn in sequence. Benefits of this technology are higher vertical resolution video images.

It is the ideal mode for LCD monitors, but unfortunately not supported by current HD capture systems, which are limited to 1080i.

With the interlace (i) technology only every second horizontal line per frame is transmitted.

Two serial complementary images in sequence deliver the necessary visual information needed for a complete video image. Pitfalls of this technology are several "interlaced" effects, e. g. motion artifacts, interline twitter and blurring.



Interlace

Progressive scan

Intuitive user guidance via optimized on screen display

- Appropriate for all MIS applications guaranteeing excellent image quality
- Seven selectable application-optimized camera settings
- Ten individually adjustable user settings



Easy to change: objective, camera head and camera cable

Latest output options

- Digital output of image data for modern capture systems and clinical networks
- 2x HDMI/1x HDMI*, 1x DVI, 1x HD-SDI

*depends on model variation

From input to output: the HD chain

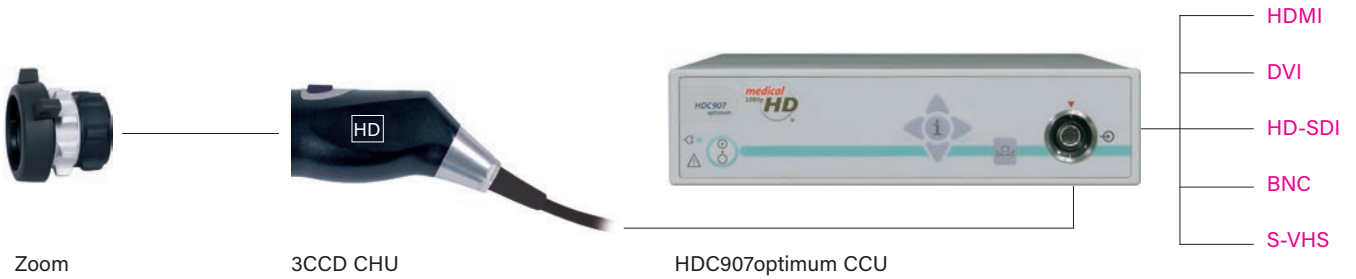

Videocoupler Zoom

- Focal length: 16-34 mm
- Parfocal*
- Brilliant optic
- Quick coupler
- Waterproof
- Autoclavable
- C-mount
- Ergonomic Design



Videocoupler Zoom

One coupler for optimum indication settings



LAP

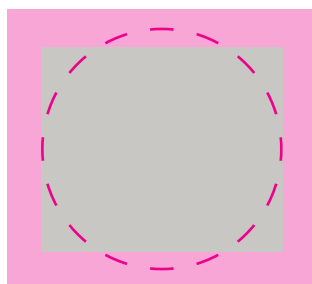

ENT

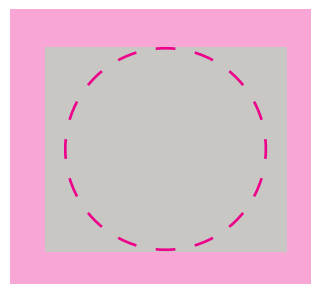

ARTHRO, HYS, URO

*A parfocal lens is a lens that stays in focus when magnification/focal length is changed

HDC907optimum

3CCD Medical-HD® Camera

- Fully digital 3CCD Camera Head
- Optional: autoclavable Camera Head
- Moderate operating temperature
- Exchangeable camera cable
- C-mount thread for easy coupler exchange and free choice of couplers

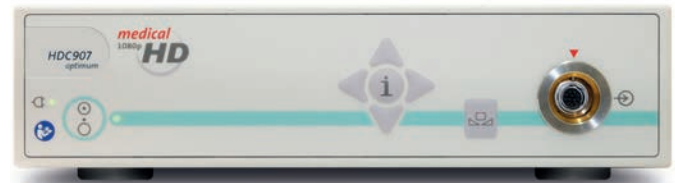

Devices

Item No.	Description
RHDC907-L01	HDC907optimum Control Unit
RHDC907-L02	HDC907optimum Camera Head PAL or NTSC (non-autoclavable)
RHDC907-L03	HDC907optimum Camera Head PAL or NTSC (autoclavable)

Accessories

Part No.	Description
RZOOM-L01	Videocoupler Zoom, Focal length = 16-34 mm, (LAP, ARTHRO, HYS, URO, ENT), autoclavable
RURO-L01	URO-Videocoupler, 18 mm, 90°
RCCB-L02	Camera cable, black

Power supply cord and further accessories available upon request.



Technical Data	HDC907optimum
Camera Head Unit (CHU)	Medical-HD® 1080p 3CCD Camera Head
Video standards	SXGA 1280 (H) x 1024 (V), horizontal resolution 1024 lines WUXGA 1920 (H) x 1200 (V), horizontal resolution 1200 lines 1080p 1920 (H) x 1080 (V), horizontal resolution 1080 lines
Sensitivity	1.5 lux
Minimum illumination	3 x 0.9 lux
AGC-Max	+18 dB
Operation	2 programmable remote head keys (user defined settings with 10 variable key functions)
Safety	Waterproofed according to IEC529, classification IPX7, completely soakable with attached EFO and camera cable (with screwed on sealing cap), Classification CF (Degree of protection against electric shock: applied part of type CF), Isolation resistance test max 500 V DC between applied part and CCU housing, autoclavable
Dimension	Ø 40 mm, L = 120 mm/Ø 1.57 in, L = 4.72 in (length incl. zoom and quick coupling)
Weight	210 g/7.4 oz (incl. zoom and quick coupling)
URO-Videocoupler	f = 18 mm, easy focusing – focus ring can be operated from left or right
Zoom objective	f = 16-34 mm
Digital zoom	2 x
Quick coupling	Fits rigid endoscopes (ocular), ISO eye piece compatible (ISO 8600-1)
Camera cable	3 m/9.8 ft highly flexible special cable, waterproof, replaceable w/o special tools short circuit proof
Camera Control Unit (CCU)	Digital signal process, +6 dB with interference suppression, continuous shutter: 1/50 to 1/16000 s, automatic signal amplification up to 400 %, automatic system check routine, setup menu for all settings, automatic white balance with digital long time memory. COLORAMA color adjustments, measuring areas SPOT and INTEGRAL, adjustable video
Signal/Noise ratio	> 62 dB
Horizontal resolution	1024 lines (SXGA), 1080 (1080i/1080p), 1200 (WUXGA)
Operation	Easy operation with membrane key: ON/OFF, WHITE BALANCE, 3 measuring areas selectable (SPOT large/small, INTEGRAL), test pattern, video level, manual COLORAMA color fine balance
Outputs	1x HD-DVI, 2x HDMI/1x HDMI*, 1x HD-SDI, 2x BNC (FBAS), 2x Y/C (S-VHS)
Interfaces	PC Interface RS 232 C, Remote (3.5 mm/1/8 in stereo jack)
Mains	Medical global power adapter 100-240 V AC +/-10 %, 50-60 Hz
Current consumption	Max. 400 mA
Classifications	Protection Class I, Type CF, IP 20
Fuses	2 x 250 V, T 0.8 A
Dimensions (w x h x d)	267 x 69 x 360 mm/10.5 x 2.7 x 14.2 in
Weight	3.9 kg/8.6 lb

*depends on model variation

LIGHT SOURCE

Classic Line

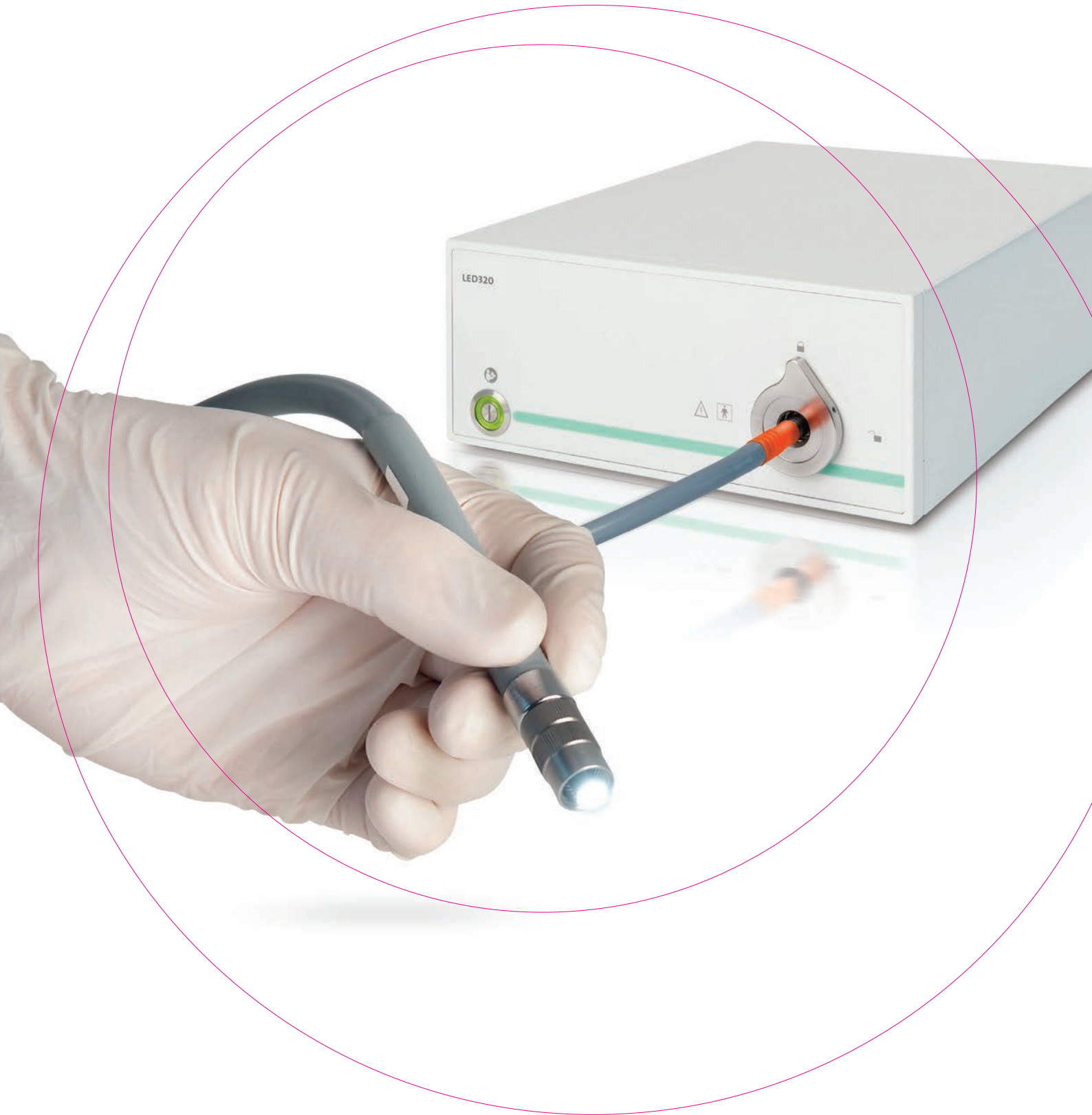



LED320

LED320 is a high brightness single white light LED Light Source for Minimally Invasive Medicine. It's lumen output surpasses 180 W Xenon-Light Sources. Due to its extremely long life expectancy (up to 10 years) the cost intensive bulb replacements as known from Xenon-Light Sources are no longer necessary.

The **LED320** exceeds the light output of 180 W Xenon-Light Sources without emitting UV or IR light. This leads to less heat transmission to the endoscope and reduces the risk of burning tissue. Additional advantages of the LED320 are the uniformly distributed illumination and the bright and more homogeneous light spot.

The **LED320** is instantly ready for use as no warm up or cool down is necessary. The multi light cable socket enables the use of light cables from different manufacturers.

LED320 has not only reduced the need for service while increasing performance, additionally it also contributes to saving the environment as no Lead (Pb) or Mercury (Hg) is used.

LED vs. Xenon

- LED light spot is brighter and more homogeneous than Xenon
- Brighter and whiter light; optimized for CCD and CMOS sensors
- Uniformly distributed illumination
- Reduced heat transmission to the endoscope due to the elimination of UV and IR light

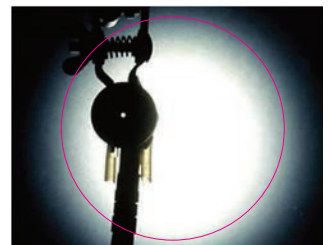
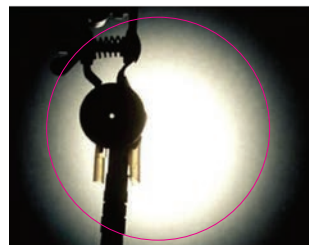
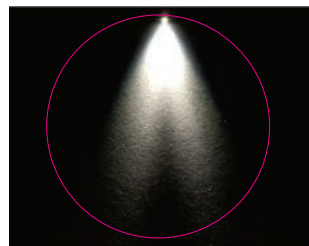

180 W Xenon

LED320

High performance endoscopic LED-Light Source

- High lumen output (superior to 180 W Xenon)
- Cost savings due to extremely long life expectancy and power saving
- No annual bulb change is necessary
- Instant ON/OFF (no warm up or cool down)
- Applicable for all endoscopic indications
- Up to 10 years of bulb life



Accessories

Part No.	Description
RLED-L01	Light Source LED320 with multi light cable socket

Power supply cord and further accessories available upon request.

Ease of use

- Multi light cable socket enables use of light cables from different manufacturers (Storz, Wolf, ACMI, Olympus)
- Single-handed exchange of light cable



Technical Data

Lamp	LED
Color temperature	6.500 K
Lumen maintenance	90 % after 10.000 h
Operation	Power switch ON/OFF
Mains	Medical world power supply, 100 to 120 V AC and 220 to 240 V AC \pm 10 %, 47/63 Hz
Power consumption	175 VA
Current consumption	115 V: 1.4 A 230 V: 0.8 A
Fuse designation	T 4.0 AH, 250 V, UL-recognized
Classifications	Protection Class I, Type BF, IP 20
Dimensions (w x h x d)	268 x 122 x 370 mm
Weight	4.9 kg

XL300

Top performance endoscopic Xenon-Light Source with micro processor control and LCD display

- 300 W Xenon lamp
- Lamp-Life LCD display and electronic lamp change indicator
- Multi standard exchangeable light cable socket
- Easy lamp replacement
- Brightness control



Devices

Item No.	Description
RXL300-L01	Light Source with light cable socket, Storz
RXL300-L03	Light Source with light cable socket, Wolf

Accessories









Part No.	Description
R900-000000-07	Adapter for light cable, Light Source, Olympus
R900-000000-01	Adapter for light cable, Light Source, Storz
R900-000000-03	Adapter for light cable, Light Source, Wolf
R900-000000-02	Adapter for light cable, endoscope, Storz/Olympus
R900-000000-04	Adapter for light cable, endoscope, Wolf
R900-000000-06	Adapter for light cable, endoscope, ACMI
R901-048180-00	Light cable for Xenon light sources, 1.8 m, Ø 4.8 mm
R901-048230-00	Light cable for Xenon light sources, 2.3 m, Ø 4.8 mm
R901-048300-00	Light cable for Xenon light sources, 3.0 m, Ø 4.8 mm
RXBO-L03	Replacement lamp module XL300

Power supply cord and further accessories available upon request.

Technical Data

Lamp	Cermax Xenon LX 300 BF 300 W
Color temperature	5.600 K
Service life	Min. 600 h
Operation	Membrane keys OFF Xenon (ON)
Mains	Medical world power supply, (AVS: automatic voltage switch), 100 to 120 V AC and 220 to 240 V AC ± 10 %, 50/60 Hz
Current consumption	4.8 to 2 A (at the end of the Xenon lamp lifespan up to 6 to 2.7 A)
Peak current	Max. 10 to 5 A (on ignition)
Fuses	2 x 250 V T 6.3 A (SB)
Classifications	Protection Class I, Type CF, IP 20
Dimensions (w x h x d)	267 x 138 x 360 mm/10.5 x 5.4 x 14.2 in
Weight	7.8 kg/17.2 lb

Combination example

Light Source	Light Cable	Endoscope
		
R900-000000-07, Olympus		R900-000000-06, ACMI
		
R900-000000-01, Storz		R900-000000-02, Storz
		
R900-000000-03, Wolf		R900-000000-04, Wolf

LED 3000

HIGH INTENSITY LIGHTSOURCE





- PHASER® Technology Included
- Turret multi connector (optional)
- Low noise, low heat conduction
- Pure daylight quality

Devices

Item No.	Description
RLED3000S	Storz (standard) adapter, automatic light intensity control
RLED3000W	Wolf adapter, automatic light intensity control
RLED3000O	Olympus adapter, automatic light intensity control
RLED3000T	Turret adapter, automatic light intensity control



Turret, multi connector (optional):

Olympus	
ACMI	
Wolf	
Storz	

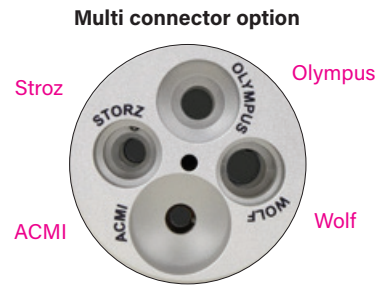

Technical Data

Lamp	Daylight quality, 6000 K (+/-500 K) Lifetime: ≤30.000 hr
Voltage range (current consumption)	100-240 V (130 VA)
Frequency	50-60 Hz
Device protection	2x T6, 3 A
Video In	1x Video
Protection class (acc. to IEC 60601-1)	I
Safety class	BF
IP Code	20
Standard	IEC 60601-1-2
Device classification (acc. to MDD 93/42/EEC)	I
Dimensions (w x h x d)	355 x 120 x 340 mm
Weight	approx. 10 kg
Delivery contains	Light source, mains cable, user manual, BNC cable

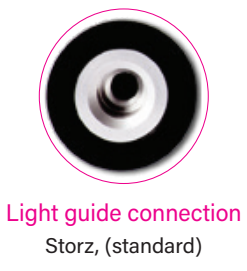

LED 1000

HIGH INTENSITY LIGHTSOURCE

- Low noise, low heat conduction
- Electronical light control via buttons
- Pure daylight quality
- Waterproof touch control panel

Devices

Item No.	Description
RLED1000S	Storz (standard) adapter, automatic light intensity control
RLED1000W	Wolf adapter, automatic light intensity control
RLED1000O	Olympus adapter, automatic light intensity control



Technical Data

Lamp	Daylight quality, 6500 K Lifetime: > 20.000 hr
Light guide connection	Storz, Wolf adapter
Voltage range (current consumption)	100-240 V (130 VA)
Frequency	50-60 Hz
Device protection	2x T3, 15 A
Video In	1x Video
Protection class (acc.to IEC 60601-1)	I
Safety class	BF
IP code	20
Standard	IEC 60601-1-2
Device classification (acc. to MDD 93/42/EEC)	I
Dimensions (w x h x d)	355 x 103 x 253 mm
Weight	approx. 4,5 kg
Delivery contains	Light source, mains cable, user manual, BNC cable (optional)

HALOGEN HL 150

- Small compact design
- Exchangeable lightguide adapter
- Mechanical diaphragm
- Low heat conduction

Devices

Item No.	Description
RHL150	Storz (standard) adapter



Technical Data

Lamp	150 W (1 Halogen reflector lamp), 15 V
Light guide connection	Storz (standard), Wolf, Olympus, ACMI
Intensity control	Stepless, mechanical diaphragm
System	Power supply: 115/230 V (+/- 10%) switchable Fine fuses: 5x20mm (230 V: T1,6 A 115 V: T3,15 A) Power consumption: max. 190 VA
Protection class (acc. to IEC 60601-1)	I
Safety class	BF
IP Code	20
Standard	IEC 60601-1-2
Device classification (acc. to MDD 93/42/EEC)	I
Dimensions (w x h x d)	175 x 82,5 x 202 mm
Weight	approx. 2,5 kg
Delivery contains	Light source, mains cable, user manual, BNC cable

PUMP SYSTEM

Multi - Indication Pump



Multi-Indication Pump

Thinking ahead: Four devices in one

4 in 1

- Laparoscopy
- Arthroscopy
- Hysteroscopy
- Urology

Resource-saving, simple, innovative

Different Pump Systems have been used for each indication up until now. This means hospitals increasingly face problems pertaining to training time and effort, as well as logistics.

The Multi-Indication Pump facilitates everyday routine hospital activities. The ingenious device combines a streamlined design, easy operation, and maximum safety. Key parameters are seen at a glance, allowing for quick and correct actions by personnel. Clinical tests have shown that the device – and with all four indications – can be operated with confidence after just one training session.

Stringent safety measures reliably prevent overpressure in the application area. Each device is the culmination of over 40 years of expertise and experience in the field of developing pumps.



Innovative: The Pump head is integrated in the housing and allows easy insertion of the tube.

Patient safety

The Pump can be used with up to four indications. Each indication can be unlocked individually as well as combined with one another. The automatic instrument recognition optimally adjusts the Pump to the instrument to be used. A transponder in the tube ensures the highest level of patient safety and maximizes pump output. The device is also equipped with a vacuum pump for suction, a 5.7" touch screen display, and an optional foot switch. The Pump is designed for more than 15 languages.



An original tube set with transponder protection.

Accessories

Part No.	Description
RAPUH302-L01	Pump

Accessories

Part No.	Description
RT0505-01	Tube set for Irrigation, disposable
RT0506-01	Tube set for Irrigation, reusable, 20 uses
RT0500-01	Day patient tube set for Irrigation, disposable*
RT0501-01	Day tube for Irrigation, disposable*
RT0502-01	Tube set for Suction, disposable
RT0503-01	Tube set for Suction, 2 connectors, disposable
RT0504-01	Tube set for Vacuum, incl. Filter, disposable
RT0550-01	Transponder, Indications LAP, ARTHRO, HYS and URO
RT0551-01	Transponder, Indication LAP
RT0552-01	Transponder, Indication ARTHRO
RT0553-01	Transponder, Indication HYS
RT0554-01	Transponder, Indication URO
RZ0223-01	Differential volume scale for HYS and URO



Tube set for Irrigation, disposable
(RT0505-01)



Tube set for Irrigation, reusable, 20 uses
(RT0506-01)



Transponder

*Indications LAP, ARTHRO

Power supply cord and further accessories available upon request.



Differential volume scale
(RZ0223-01)

Technical Data

Pressure range	Laparoscopy: not adjustable Arthroscopy: 5-150 mmHg Hysteroscopy: 15-150 mmHg Urology: 15-150 mmHg
Flow range	Laparoscopy: 1.0-1.8 l/min Arthroscopy: 0.1-1.8 l/min Hysteroscopy: 50-500 ml/min Urology: 50-500 ml/min
Suction capacity	Max. 2 l/min (depending on outflow cannula)
Power supply	100-240 V~
Frequency	50-60 Hz
Power consumption	80 VA
Current consumption	100 V: 0.8 A 240 V: 0.3 A
Classifications	Protection Class I, Type BF, IP 41
Dimensions (w x h x d)	381 x 149 x 379 mm
Weight	6.3 kg

Laparoscopy

All functions required of the Pump can be adjusted via the touch screen with easy to use controls. Unambiguousness ensures maximum safety during surgery.



Arthroscopy

The clearly arranged and intuitive graphical user interface makes it possible to see all key parameters at a glance. The wash function optimizes the visual conditions in the joint. Flow and pressure are adjustable. Highly stringent safety standards prevent overpressure within the joint.



Hysteroscopy

Pressure and flow are controlled intuitively via setting keys. A scale to measure the deficit is an available option. The display prominently depicts the status of the fluid deficit.

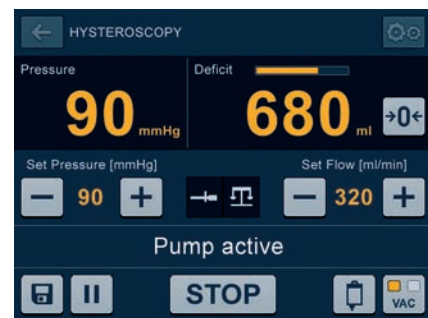

Urology

Security is the alpha and omega in the field of Minimally Invasive Surgery. The display design optimally supports handling of the Pump. Important data immediately catch the eye and action prompts facilitate proper operation of the Pump, thereby increasing safety considerably. A deficit measurement is an available option.



PUMP

Systems



A127

Pump for arthroscopy

- 1.5 l/min max. flow
- Optimized flow regulation done by automatic instrument detection and software control
- Wash function to improve visibility
- within the joint
- Flexible use due to pole mounting
- Highest patient safety due to transponder protected tube set



Accessories

Part No.	Description
RA127-L01	Pump for arthroscopy

Accessories

Part No.	Description
RT0449-01	Tube set with Spike and Luer-Lock connector male: Disposable, only Inflow, transponder protection (1 packaging = 10 pcs.)
RT0454-01	Reusable tube set, only inflow, 20 uses, transponder protection

Power supply cord and further accessories available upon request.



Pole mounting

Technical Data

Pressure range	5-150 mmHg
Max. flow	1.5 l/min \pm 10 %
Mains	Medical world power supply, 100-240 V AC, 50-60 Hz
Power consumption	60 VA
Current consumption	100 V: 1.2 A 240 V: 0.6 A
Fuse designation	2x T 3.15 AH, 250 V
Classifications	Protection class I, Type BF, IP 41
Dimensions (w x h x d)*	240 x 103 x 221 mm
Weight	2.8 kg

*without toggle screw

A106

Pump for arthroscopy

- Easy set up
- Automatic instrument calibration
- Clear visualization of operating site
- High safety standards avoid overpressure in the joint
- Remote control from sterile field

Note: The automatic instrument calibration finds the perfect set-up for each instrument.



Accessories

Part No.	Description
RA106-L01	Pump for arthroscopy

Accessories

Part No.	Description
	Tube set with pressure chamber, Irrigation, with Spike and Luer-Lock connector male:
RZ0449-01	Disposable, sterile (1 packaging = 10 pcs.)
RZ0454-01	Reusable, 20 uses, incl. 10 membranes
RZ1424-01	Disposable, sterile, Safe-Lock (1 packaging = 10 pcs.)
RZ0106-01	Foot pedal for Irrigation Pump for arthroscopy
RZ0545-01	Cable remote control

Note: Wash function only available when remote control or foot pedal is connected.

Technical Data

Pressure range	0-200 mmHg
Flow range	0.1-1.5 l/min
High pressure safety	300 mmHg
Power supply	100-240 V~
Frequency	50-60 Hz
Power consumption	75 VA
Current consumption	100 V: 1.0 A 240 V: 0.2 A
Classifications	Protection Class I, Type BF, IP 20
Dimensions (w x h x d)	265 x 137 x 390 mm
Weight	7.1 kg

Power supply cord and further accessories available upon request.

P101

Pump for laparoscopy

- Simple set up and operation
- Easy to load tube set
- Vacuum suction included



Accessories

Part No.	Description
RP101-L01	Pump for laparoscopy, power supply: 220-240 V
RP101-L02	Pump for laparoscopy, power supply: 110-115 V

Accessories

Part No.	Description
RZ0449-01	Tube set with pressure chamber, Irrigation, with Spike and Luer-Lock connector male: Disposable, sterile (1 packaging = 10 pcs.)
RZ0454-01	Reusable, 20 uses, incl. 10 membranes
RZ1425-01	Tube set, suction, reusable, 20 uses
RZ1426-01	Tube set, vacuum, reusable, 20 uses
RZ0553-01	Wire Hoop for Bemis Container
RZ0554-01	Bemis Container, 3 L, disposable (1 packaging = 2 pcs.)
RZ0555-01	Bemis Container, 3 L, disposable (1 packaging = 36 pcs.)
RZ0556-01	Filter P06, sterile

Technical Data

Max. Flow Rate Irrigation	1.8 l/min (± 10 %)
Suction	1.8 l/min (+ 0.4/- 0.1 l/min)
Max. Pump Capacity	400 mmHg (± 50 mmHg)
Suction	Between -50 kpa and -60 kpa
Power Supply	100 V~/110-115 V~/220-240 V~
Frequency	50-60 Hz
Power consumption	55 VA
Current consumption	100 V: 0.5 A 230 V: 0.3 A
Classifications	Protection Class I, Type BF, IP 41
Dimensions (w x h x d)	280 x 137 x 408 mm
Weight	5.9 kg

Power supply cord and further accessories available upon request.



UP100

Pump for urology

- Easy set up
- Automatic instrument calibration
- Precise control and regulation of pressure
- Clear visualization of operating site

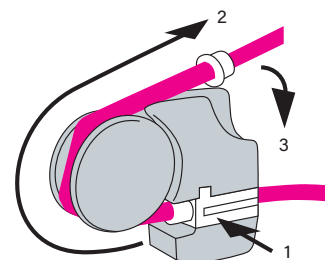

Easy to load tube set in three steps.

Accessories

Part No.	Description
RUP100-L01	Pump for arthroscopy

Accessories

Part No.	Description
RZ0449-01	Tube set with pressure chamber, Irrigation, with Spike and Luer-Lock connector male: Disposable, sterile (1 packaging = 10 pcs.)
RZ0454-01	Reusable, 20 uses, incl. 10 membranes
RZ1406-01	Tube set, outflow, disposable, sterile (1 packaging = 10 pcs.)

Power supply cord and further accessories available upon request.

Technical Data

Pressure range	15-150 mmHg
Flow range	30-500 ml/min
High pressure safety	200 mmHg
Power supply	100-240 V~
Frequency	50-60 Hz
Power consumption	82 VA
Current consumption	100 V: 0.9 A 240 V: 0.3 A
Classifications	Protection Class I, Type BF, IP 41
Dimensions (w x h x d)	360 x 130 x 305 mm
Weight	6.3 kg

H108

Pump for hysteroscopy

- Easy set up and quickest start-up time
- Automatic instrument calibration
- Advanced safety for pressure and flow meeting highest international standards
- Optional fluid deficit monitoring



Accessories

Part No.	Description
RH108-L01	Pump for hysteroscopy

Accessories

Part No.	Description
	Tube set with pressure chamber, Irrigation, with Spike and Luer-Lock connector male:
RZ0449-01	Disposable, sterile (1 packaging = 10 pcs.)
RZ1424-01	Disposable, sterile, Safe-Lock (1 packaging = 10 pcs.)
RZ0454-01	Reusable, 20 uses, incl. 10 membranes
RZ1406-01	Tube set, outflow, disposable, sterile (1 packaging = 10 pcs.)
RZ0123-01	Bottle scale
RZ0554-01	Bemis Container, 3 L, disposable (1 packaging = 2 pcs.)
RZ0555-01	Bemis Container, 3 L, disposable (1 packaging = 36 pcs.)

Technical Data

Pressure range	15-150 mmHg
Flow range	30-500 ml/min
High pressure safety	200 mmHg
Power supply	100-240 V~
Frequency	50-60 Hz
Power consumption	45 VA
Current consumption	100 V: 0.3 A 240 V: 0.2 A
Classifications	Protection Class I, Type BF, IP 41
Dimensions (w x h x d)	265 x 137 x 390 mm
Weight	4 kg

Power supply cord and further accessories available upon request.

HM4

Fluid Management System for hysteroscopy

- Optimized flow using FluidMatic
- Easy use and patient safety
- Large deficit and volume display for precise monitoring of fluid loss
- Several bag hooks and container holder
- Easy bag and container change

Accessories

Part No.	Description
RHM4-L01	RHM4 (RH100 – Name of Pump, RM100 – Name of scale unit)

Accessories

Part No.	Description
RZ0449-01	Tube set with pressure chamber, Irrigation, with Spike and Luer-Lock connector male: Disposable, sterile (1 packaging = 10 pcs.)
RZ0454-01	Reusable, 20 uses, incl. 10 membranes
RZ1406-01	Tube set, outflow, disposable, sterile (1 packaging = 10 pcs.)
RZ0553-01	Wire Hoop for Bemis Container
RZ0554-01	Bemis Container, 3 L, disposable (1 packaging = 2 pcs.)
RZ0555-01	Bemis Container, 3 L, disposable (1 packaging = 36 pcs.)

Power supply cord and further accessories available upon request.



Technical Data

Pressure range	15-150 mmHg
Flow range	30-500 ml/min
High pressure safety	200 mmHg
Power supply	100-240 V~
Frequency	50-60 Hz
Power consumption	82 VA
Current consumption	100 V: 0.9 A 240 V: 0.3 A
Classifications	Protection Class 1, Type BF, IP 41 (pump), IP 21 (scale)
Dimensions (w x h x d)	710 x 1400 x 810 mm
Weight	27 kg

Accessories available for **A106, P101, UP100, H108 and HM4**



Tube set with pressure chamber, Irrigation, with Spike and Luer-Lock connector male, disposable, sterile
(RZ0449-01)



Tube set with pressure chamber, Irrigation, with Spike and Luer-Lock connector male*, reusable, 20 uses, incl. 10 membranes
(RZ0454-01)

Accessories **A127**



Tube set with Spike and Luer-Lock connector male, disposable, only Inflow, transponder protection
(RT0449-01)



Tube set with Spike and Luer-Lock connector male, reusable, only inflow, 20 uses, transponder protection*
(RT0454-01)

* Spikes, Luer-Lock and membranes as separate spareparts available
Further accessories available upon request.

Accessories **HM4, H108, P101**



Bottle scale (**RZ0123-01, for RH108 only**)
and Bemis Container
(disposable, **RZ0554-01 / RZ0555-01**)



Filter, sterile
(**RZ0556-01, for RP101 only**)

Accessories **A106**



Cable remote control
(**RZ0545-01**)



Foot pedal for Irrigation
Pump for arthroscopy
(**RZ0106-01**)

Note: Wash function only available when remote control or foot pedal is connected.

Further accessories available upon request.

INSUFFLATOR

50L - Insufflator



50 L-Insufflator

Multi-mode Powerhouse

50 L

- Three additional modes – Bariatric, Pediatric and Vessel Harvesting
- High-end performance
- Gas heating – reusable and disposable

Higher performance enhances safety in the operating room

The new **50 L-Insufflator** adds even more safety during minimally invasive surgeries delivering the performance needed – even under extreme conditions such as obesity of the patient to maintain a stable pneumoperitoneum.

In pediatric or vessel harvesting mode, the insufflator optimally controls according to the different anatomical requirements.

Another plus for all surgical procedures is its ease of use. The **50 L-Insufflator** has a color touchscreen for a high degree of user-friendliness.



A connector for standard insufflation tube sets. Disposable and autoclavable tube sets available.

Accessories



Tube set, insufflation and gas heating, reusable, 100 uses
(RZ0280)



High pressure hose CO₂, gas connection, bottle DIN/device US (RZ5044-01)



CO₂ gas connector, angled
(RZ5077-01)



NIST adapter for universal gas connector (RZ5074-01)

The gas port can be connected with all major gas supply systems. Various adapters and supply hoses are available for this purpose. Opening the device is not required.

Devices

Item No.	Description
RFM134-L01	50 L-Insufflator

Accessories

Part No.	Description
RZ0452-01	Tube set, insufflation, reusable, 20 uses
RZ0280	Tube set, insufflation and gas heating, reusable, 100 uses
RZ0293	Tube set, insufflation with filter, disposable, sterile
RZ0260	Tube set, insufflation and gas heating, disposable, sterile
RZ0536	Filter, single use, sterile, ISO-ISO
RZ5044-01	Hose for CO ₂ gas bottle DIN/US, 1.5 m
RZ0499-01	Hose for CO ₂ gas bottle Pin/US, 1.5 m
RZ5030-01	Hose for CO ₂ central gas DIN/NIST, 3 m
RZ5031-01	Hose for CO ₂ central gas DIN/NIST, 5 m
RZ5074-01	NIST adapter for universal gas connector (central gas supply EU)
RZ5077-01	CO ₂ gas connector, angled
RZ5072-01	Sinter filter for universal gas connector (5 pcs.)

Technical Data

Insufflation medium	Med. CO ₂
Max. gas flow	50 l/min
Pressure range	1-30 mmHg
Power supply	100-240 V~
Frequency	50-60 Hz
Power consumption	150 VA
Current consumption	100 V: 0.8 A 240 V: 0.3 A
Classifications	Protection Class I, Type BF, IP 21
Dimensions (w x h x d)	406 x 150 x 395 mm
Weight	10 kg

Power supply cord and further accessories available upon request.

INSUFFLATOR

30L - Insufflator



30 L-Insufflator

Safe technology that adapts to the patient

30 L

- Reliable base unit
- Highest safety
- Mature technology

Easy to use, universal, efficient

A highly reliable device for demand of daily hospital routines. Easy to use by the staff and comprehensive safety components to protect patients.

The maximum flow capacity is 30 liters per minute. The start settings for flow and pressure are customized individually. The Insufflator has a reliable venting system that safely reduces excess pressure in the abdomen. A exchangeable gas filter protects the device from gas supply contamination.

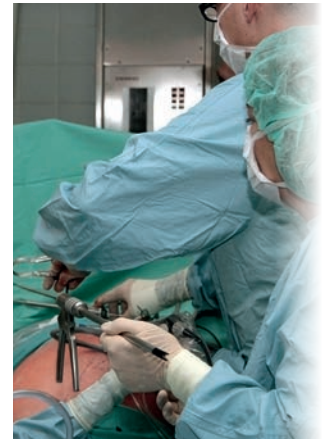

A connector for almost all standard insufflation tubes. Disposable and autoclavable tube sets available.



Accessories



Tube set, insufflation and gas heating, reusable, 100 uses
(RZ1422-01)



High pressure hose CO₂, gas connection, bottle DIN/device US (RZ5044-01)



Gas connector, angled
(RZ5071-01)



NIST adapter for universal gas connector (RZ5074-01)

The gas port can be connected with all major gas supply systems. Various adapters and supply hoses are available for this purpose. Opening the device is not required.

Devices

Item No.	Description
RF128-L01	30 L-Insufflator

Accessories

Part No.	Description
RZ0452-01	Tube set, insufflation, reusable, 20 uses
RZ1422-01	Tube set, insufflation with filter, disposable, sterile
RZ0536	Filter, single use, sterile, ISO-ISO
RZ5044-01	Hose for CO ₂ gas bottle DIN/US, 1.5 m
RZ0499-01	Hose for CO ₂ gas bottle Pin/US, 1.5 m
RZ5030-01	Hose for CO ₂ central gas DIN/NIST, 3 m
RZ5031-01	Hose for CO ₂ central gas DIN/NIST, 5 m
RZ5074-01	NIST adapter for universal gas connector (central gas supply EU)
RZ5071-01	Gas connector, angled
RZ5072-01	Sinterfilter for universal gas connector (5 pcs.)

Technical Data

Insufflation medium	Med. CO ₂
Max. gas flow	30 l/min
Pressure range	1-30 mmHg
Power supply	100-240 V~
Frequency	50-60 Hz
Power consumption	150 VA
Current consumption	100 V: 0.5 A 240 V: 0.2 A
Classifications	Protection Class I, Type BF, IP 41
Dimensions (w x h x d)	381 x 149 x 379 mm
Weight	7.5 kg

Power supply cord and further accessories available upon request.

INSUFFLATOR

Classic Line



F102

Insufflator for laparoscopy

- 20 l/min flow
- Easy set up
- High safety
- ISO standard at patient exit
- User-programmable



Accessories

Item No.	Description
RF102-L04	Insufflator for laparoscopy, gas connection CO ₂ , US

Accessories

Part No.	Description
RZ0452-01	Tube set, insufflation, reusable, 20 uses
RZ1422-01	Tube set, insufflation with fi lter, disposable, sterile
RZ0536	Filter, single use only, sterile, ISO-ISO
RZ5044-01	High pressure hose CO ₂ , Bottle connection: DIN, Device connection: US, Length: 1.5 m
RZ5030-01	High pressure hose CO ₂ for central gas supply, 3 m, NIST/DIN
RZ5031-01	High pressure hose CO ₂ for central gas supply, 5 m, NIST/DIN
RZ5010-01	Connector CO ₂ NIST for central gas supply (EU standard)
RZ5020-01	Connector CO ₂ DISS for central gas supply (US standard)
RZ5070-01	Gas connector US, angled standard (F102/F104)
RZ5072-01	Sinter fi lter for universal gas connection (1 packaging = 5 pcs.)

Power supply cord and further accessories available upon request.

Note: The use of non-medical CO₂ may damage the device.
Always use sterile fi lter when operating with reusable tube set.

Technical Data

Insufflation medium	Med. CO ₂
Max. gas fl ow	20 l/min
Pressure range	1-30 mmHg
Power supply	100-240 V~
Frequency	50-60 Hz
Power consumption	75 VA
Current consumption	100 V: 0.7 A 240 V: 0.3 A
Classifications	Protection Class I, Type BF, IP 41
Dimensions (w x h x d)	267 x 138 x 410 mm
Weight	7 kg

F104

Insufflator for laparoscopy

- 40 l/min flow
- High safety
- Easy set up
- Large text display (multi-lingual)
- User-programmable
- Integrated gas heating
- Pressure relief system and integrated fluid sensor



Accessories

Item No.	Description
RF104-L01	Insufflator for laparoscopy, gas connection CO ₂ , US Language: English, German, French, Spanish
RF104-L02	Insufflator for laparoscopy, gas connection CO ₂ , US Language: Italian, Greek, Danish, Dutch

Accessories

Part No.	Description
RZ0452-01	Tube set, insufflation, reusable, 20 uses
RZ1422-01	Tube set, insufflation with filter, disposable, sterile
RZ1415-01	Tube set, insufflation and gas heating, reusable, 100 uses
RZ0536	Filter, single use only, sterile, ISO-ISO
RZ5044-01	High pressure hose CO ₂ , Bottle connection: DIN, Device connection: US, Length: 1.5 m
RZ5030-01	High pressure hose CO ₂ for central gas supply, 3 m, NIST/DIN
RZ5031-01	High pressure hose CO ₂ for central gas supply, 5 m, NIST/DIN
RZ5010-01	Connector CO ₂ , NIST for central gas supply (EU standard)
RZ5020-01	Connector CO ₂ , DISS for central gas supply (US standard)
RZ5070-01	Gas connector US, angled standard (F102/F104)
RZ5072-01	Sinterfilter for universal gas connection (1 packaging = 5 pcs.)

Technical Data

Insufflation medium	Med. CO ₂
Max. gas flow	40 l/min
Pressure range	1-30 mmHg
Power supply	100-240 V~
Frequency	50-60 Hz
Power consumption	145 VA
Current consumption	110 V: 1.3 A* 230 V: 0.6 A*
Classifications	Protection Class I, Type BF, IP 40
Dimensions (w x h x d)	267 x 138 x 410 mm
Weight	7 kg

*with reusable heater tubing

Power supply cord and further accessories available upon request.

Tube sets and filter



Tube set, insufflation with filter,
disposable, sterile
(RZ1422-01)



Tube set, insufflation,
reusable, 20 uses
(RZ0452-01)



Tube set, insufflation and gas
heating, reusable, 100 uses
(RZ1415-01)



Filter, single use only,
sterile, ISO-ISO
(RZ0536)

Note: Always use sterile filter when operating with reusable tube set.

Further accessories available upon request.

Gas connectors and high pressure tubes



Connector CO₂, US
(broad standard)
(RZ0175-01)



Connector CO₂, NIST for central
gas supply (EU standard)
(RZ5010-01)



Connector CO₂, DISS for central
gas supply (US standard)
(RZ5020-01)



High pressure hose CO₂,
bottle connection: DIN/
device connection: US,
length: 1.5 m
(RZ5044-01)



High pressure hose CO₂
for central gas supply,
NIST/DIN, length: 3 m
(RZ5030-01)

Further accessories available upon request.

MEDICAL Monitors



Medical Monitors

The solution you are looking for

- TFT-Displays with wide-screen-format
- Display with all-round viewing angle
- Hygienic design with full glass front

Due to the completely closed metal housing, hygienic optimized design and the anti-reflective coated safety glass, these displays provide you with the ability to easily disinfect the monitor as well as offering perfect protection for the high-performance hardware inside.

Monitor stand available upon request.

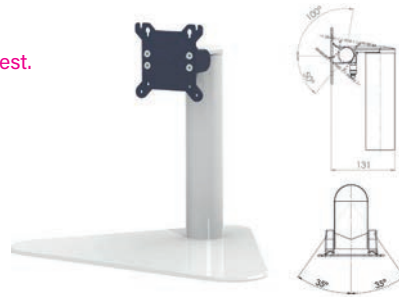

MD-32



MD-27



MD-23

Technical Data	RMD-23	RMD-27-Slim	RMD-32
Design	23" TFT-widescreen display	27" TFT-widescreen display	32" TFT-widescreen display
Protective pane	integrated (touchscreen/in planning*)		
Dimensions (w x h x d)	ca. 557 x 357 x 60 mm	ca. 655 x 432 x 60 mm	ca. 770 x 510 x 70 mm
Mounting	Built-in VESA-100 interface extensive mounting solutions available as accessories		
Weight	7.4 kg (without accessory)	10.5 kg (without accessory)	17 kg (without accessory)
Power supply unit	100-240 V/ 50-60 Hz intern 80 W		
Front keypad	ON/OFF button, six controls for OSD		
Display module			
Active area	509 x 286 mm	597 x 335 mm	698.4 x 392.9 mm
Native resolution	1920 x 1080 pixel	1920 x 1080 pixel	1920 x 1080 pixel
Brightness	250 cd/m ²	350 cd/m ²	400 cd/m ²
Contrast	1000:1		1300:1
Viewing angle (h/v)	178°/178°		
Response time	< 14 ms (G-to-G)	8 ms (G-to-G)	8 ms (G-to-G)
Colors	16.7 millions		
Interface			
Analog	VGA D-SUB-15		
Digital	DVI-I		DVI-D
S-Video	4-pole mini DIN		
Composite Video	RCA (PAL/NTSC)		
OSD			
Language selection	German (English, French, Italian, Spanish, Polish*)		
VGA	Size and position, clock and phase		
Viewing settings	Brightness, contrast, color temperature, gamma, input signal		
Scope of delivery			
Device	MD-23	MD-27	MD-32
Cable kit	DVI-D (VGA, Component Video, S-Video, Composite-Video*)		
Acceptable ambient conditions			
Temperature	0 to +60 °C/+5 to +35 °C when stored/in operation		
Relative humidity	5 % to 95 %/ 20 % to 80 % non-condensing when stored/in operation		
Supplementary standard			
DIN EN 60601-1: 2007	Medical electrical equipment: General requirements for basic safety and essential performance		
DIN EN 60601-1-2: 2007	Medical electrical equipment: General requirements for basic safety and essential performance Collateral standard: Electromagnetic compatibility – Requirements and tests		

*optional

PP Trolley

PROFESSIONAL POWER TROLLEY

Basic structure

The **PROFESSIONAL POWER** trolley is made up of:

- Base made of steel sheets coated with baked RAL 7035 epoxy powder
- Shelf-holder columns made of aluminum painted with RAL 7035 epoxy powder, with colored stripes
- Cables holder column, made of aluminum, coated with baked epoxy powder, RAL 7035, equipped with removable closure for cables allocation and their easy inspection
- Shelves made of steel sheet coated with baked epoxy powder, suitably shaped in order to avoid accidental falls of objects
- Shelves can be easily mounted and adjusted at different heights (step 2.5 cm), according to the Customer's needs
- Handle with anti-slip grip for a better mobility
- No. 4 twinned wheels with a diameter of 125 mm (2 with brake) anti-noise and anti-tracking

The **PROFESSIONAL POWER** trolley can be enriched with many accessories, due to the specific use of the trolley (keyboard holder shelves, mouse pad, drawers, infusion stand holder, endoscope holder, cylinders holder, monitor holder, swiveling arms, etc.).



Devices

Item No.	Description
RPP600 RI	OR Trolley

Technical Data

Dimensions (w x h x d)	745 x 691 x 1479 mm
1 Shelf	600 x 300 mm
4 Shelves	600 x 500 mm
1 Drawer	600 x 500 mm
1 Oxygen bottle holder	Ø 150 mm
1 Keyboard holder	
1 Monitor holder	

SET/9500004: Standard Laparoscopic Instruments Set

1x	R010-100309-000	Laparoscope 10 mm Ø, 0°, autoclavable intergrated fiber optic for illumination 316 mm working length
2x	R025-110101-001	Multi function trocarsleeve 11 mm Ø, Insufflation stop cock, interchangeable metal tube smooth 101 mm working length
2x	R020-110101-024	Safetytrocar 11 mm Ø oblique end f. trocar sleeve w. 101 mm working length
3x	R020-055095-024	Safetytrocar 5,5 mm Ø oblique end f. trocar sleeve w. 95 mm working length
3x	R025-055095-001	Multi function trocarsleeve 5,5 mm Ø, Insufflation stop cock, interchangeable metal tube smooth 95 mm working length
1x	R026-110055-002	Reducing adapter w. silicon drape 11 > 5,5 mm
1x	R027-050110-000	Dilation set 5 < 11 mm guide probe and dilation sleeve
1x	R033-050330-236	Reddick-Olsen Grasping forceps 5 mm Ø, 330 mm lg., ergo uni ratchet handle w. HF rotatable, dismantable, mod. lap. inst.
1x	R034-050330-250	Davis & Geak forceps w. reservoir, 5 mm Ø, 330 mm working length, ergo handle w. HF rotatable, dismantable, mod. lap. inst.
1x	R033-050330-212	MARYLAND dissector curved 5 mm Ø, atraum. 330 mm lg., ergo uni ratchet handle w. HF rotatable, dismantable, mod. lap. inst.
1x	R044-050330-116	Hook scissors straight, 5 mm Ø, 330 mm lg., ergo handle w. HF dismantable, rotatable, mod. lap. Inst.
1x	R044-050330-112	Metzenbaum scissors left curved, 5 mm Ø, 330 mm lg., ergo handle w. HF dismantable, rotatable, mod. lap. Inst.
1x	R044-050330-120	Micro scissors curved, 5 mm Ø, 330 mm lg., ergo handle w. HF dismantable, rotatable, mod. lap. Inst.
1x	R064-050000-006	Suction-irrigation handle ergonomic 2-way stop-cock, HF-connector 4 mm male LL-connector for adaptable elektrodes
1x	R064-050330-003	L-hook-electrode-shaft assembly, monopole 5 mm Ø, 330 mm working length, adaptable on valvehandles of serie R064-
1x	R060-050330-001	Button electrode monopolar 5 mm Ø, 340 mm working length handle small HF-connector male
1x	R060-080040-003	Monopolar HF-connecting cable, 3 mtr. lg. 8 mm PIN for US HF-units 4 mm socket instrument side
1x	R066-050340-601	Bipolar grasper Hirsch 5 mm Ø, 340 mm working length, jaws fenestrated wave wire, ring plastic handle, modular instrument system rotatable, dismantable
1x	R067-050340-003	Hook electrode L-shaped, 5 mm Ø, bipolar, 340 mm working length small handle, HF-connector european
1x	R065-040000-003	Bipolar connecting cable 3 m lg. 2 banana plugs f. US generators, euro flat plug round f. bipolar instruments with protection
1x	R081-050330-001	Cholangiography fixation clamp 5 mm Ø, channel for 6 Fr. catheters, 330 mm working length, handle with ratchet
1x	R080-020600-201	Cholangiographiy-Catheter 2 mm Ø, 60 cm long LL-connector female
1x	R058-050330-361	Needleholder/-positioner str.serrated, 5 mm Ø, 330 mm lg., axial ratchet handle o. HF dismantable, rotatable, mod. lap. inst.
1x	R058-050330-352	Needle holder left curved, w. TC, 5 mm Ø, 330 mm lg., axial ratchet handle o. HF dismantable, rotatable, mod. lap. inst.
1x	R050-050330-01	Knot tier with eye 5 mm Ø, 330 mm working length
1x	R056-100330-03	Clip Applier for Ethicon Titan Clips LT300 medium/large, "Paraclose-system", 10 mm Ø, 330 mm working length 360° rotatable, dismantable (3-parts)
1x	R078-000000-199	Irrigation-suction set 5 / 10 mm Ø, 330 mm long handle w. 2 large trumpet valves tubes 5 + 10 mm Ø, 4 x 4 holes
1x	R090-050330-001	Palpation Probe graduated 5 mm Ø, 330 mm working length
1x	R092-100380-005	Endo -Retractor 10 mm Ø with 5 fingers spreadable and angleable, 340 mm working length, LL-adapter for cleaning
1x	R099-000250-003	Speculum retractor, 3 blades 60 mm working length, f. gall bladder extraction suitable for 11 mm trocar sleeve
1x	R050-028170-001	Suture instrument for subcutaneous facial closure, 2,8 mm Ø, 17 cm

SET/9502000: Set for gynaecology

1x	R075-020120-001	Insufflations-needle acc. to Veress 2,00 x 120 mm
1x	R010-100309-030	Laparoscope 10 mm Ø, 30°, autoclavable intergrated fiber optic for illumination 316 mm working length
2x	R025-110101-001	Multi function trocarsleeve 11 mm Ø, Insufflation stop cock, interchangeable metal tube smooth 101 mm working length
2x	R020-110101-001	Trocar pyramidal tip 11 mm Ø, f. trocar sleeve w. 101 mm working length
2x	R025-055095-001	Multi function trocarsleeve 5,5 mm Ø, Insufflation stop cock, interchangeable metal tube smooth 95 mm working length
2x	R020-055095-011	Safetytrocar pyramidal tip, 5,5 mm Ø, autom. cutting protection w. obturator, f. trocar sleeve w. 95 mm working length
1x	R075-050330-014	Puncture- and injection needle 5 mm Ø, 330 mm working length, LL-adapter proximal distal needle 1,4 mm (17G) Ø 330 mm
2x	R026-110055-001	Reducing adapter 11 > 5,5 mm
1x	R033-050360-240	Mahnes-Grasping forceps, w. mouse teeth 360 mm lg., ergo uni ratchet handle w. HF rotatable, dismantable, mod. lap. inst.
1x	R033-050360-242	Claw grasper 3 x 2 teeth, 5 mm Ø, 360 mm lg., ergo uni ratchet handle w. HF rotatable, dismantable, mod. lap. inst.
1x	R033-050360-243	Claw grasper long 3 x 2 teeth, 5 mm Ø, 360 mm lg., ergo uni ratchet handle w. HF rotatable, dismantable, mod. lap. inst.
1x	R033-050360-216	Dissecting frcps fenestrated, slim 5 mm Ø, 360 mm lg., ergo uni ratchet handle w. HF rotatable, dismantable, mod. lap. inst.
1x	R033-050360-212	MARYLAND dissector curved 5 mm Ø, atraum. 360 mm lg., ergo uni ratchet handle w. HF rotatable, dismantable, mod. lap. inst.
1x	R033-050360-225	DOLPHIN grasper, bottle nose, 5 mm Ø, 360 mm lg., ergo uni ratchet handle w. HF rotatable, dismantable, mod. lap. inst.
1x	R044-050360-114	Peritoneal scsr serrated straight, 5 mm Ø, 360 mm lg., ergo handle w. HF dismantable, rotatable, mod. lap. Inst.
1x	R044-050360-112	Metzenbaum scissors left curved, 5 mm Ø, 360 mm lg., ergo handle w. HF dismantable, rotatable, mod. lap. Inst.
1x	R044-050360-410	Biopsy punch without thorn, 5 mm Ø, 360 mm lg., ergo handle w. HF dismantable, rotatable, mod. lap. Inst.
1x	R044-100360-710	MAYO Large OP- Scissors, 10 mm Ø, 360 mm lg., ergo handle w. HF dismantable, rotatable, mod. lap. Inst.
1x	R067-000000-700	Ringhandle for bipolar laparoscopic instruments, handle alone w/o accessories POWERGRIP
1x	R067-050340-700	Shaft tube 5 mm Ø, 340 mm working length f. Powergrip bipolar forceps
1x	R067-000340-713	Bipolare forceps fenestrated 5 mm Ø, 340 mm working length insert alone POWERGRIP
1x	R065-040125-005	Bipolar connecting cable 5 mtr. long for Erbe / Storz HF-generators european plug for instruments
1x	R061-050340-003	Hook electrode L-shaped, 5 mm Ø, monopolar, 340 mm working length HF-connector male
1x	R061-050340-004	Spatula electrode monopolar 5 mm Ø, 340 mm working length HF-connector male
1x	R079-050340-204	Suction-irrigation set 5 mm Ø, 340 mm lg. pistol handle w. 2-way valve, olives shaft w. 4 holes
1x	R079-100340-204	Suction-irrigation set 10 mm Ø, 340 mm lg. pistol handle w. 2-way valve, olives shaft w. 4 holes
1x	R090-050330-001	Palpation Probe graduated 5 mm Ø, 330 mm working length
1x	R099-000250-003	Speculum retractor, 3 blades 60 mm working length, f. gall bladder extraction suitable for 11 mm trocar sleeve
1x	R058-050360-360	Needleholder/-positioner straight, 5 mm Ø, 330 mm lg., axial ratchet handle o. HF dismantable, rotatable, mod. lap. inst.
1x	R050-028170-001	Suture instrument for subcutaneous facial closure, 2,8 mm Ø, 17 cm
1x	R050-050330-01	Knot tier with eye 5 mm Ø, 330 mm working length
1x	R050-050340-00	Fascia Closure Device 2,3 mm Ø, 140 mm working length

A

Abdominal retractor 9/6
 Accessories for trocar sleeves 2/18-2/19
 Accessories for HD cameras 15/7
 Accessories for pump systems
 16/14-16/15
 Accessories for insufflators 17/12-17/13
 Adapter electrode handle 6/4
 Alligator forceps 12/11
 Alligator grasping & biopsy forceps 4/12
 ALLIS forceps 11/5
 Anti fog liquid 1/5
 Aqua dissector cannula 7/3
 Arthroscopy 16/5
 Axial handles 3/4, 4/5, 5/4, 10/8

B

BABCOCK clamp 3/17
 BABCOCK grasping forceps 3/20, 3/22
 Ball electrode 6/6
 Biopsy cup 4/12-4/13, 10/15
 Biopsy punch 4/14, 12/11
 Bipolar coagulation forceps 6/12, 6/19
 Bipolar connecting cables 6/17
 Bipolar electrodes 6/10-11
 Bipolar shaft tubes 6/15
 BLAKESLEY tumor forceps 4/12
 Bowel grasper 3/24

C

Cables bipolar 6/17
 Cables light guide 14/1
 Cables monopolar 6/7
 Cameras 15/2, 15/4-15/5, 15/7-15/8,
 15/10-15/14
 Cannulas 7/1-7/3, 7/10-7/11,
 10/22-10/23, 12/14
 Carbon handles 3/2-3/3, 4/3-4/4,
 5/2-5/3, 10/6-10/7
 Cholangiography catheter 8/1
 Cholangiography grasping forceps 8/2
 Claw grasping forceps
 3/13, 3/19, 10/11-10/12
 Cleaning brush 3/26
 Cleaning paste 1/5
 Clip applying forceps 5/16-5/19
 Coagulation electrodes 12/16
 COHEN intra uterine cannula 12/14
 COLLIN clamp 3/22
 Cone 12/14-12/15
 Connectors 14/2
 Container sterilization 1/6-1/7
 CROCE-OLMI atrumatic grasping
 forceps 3/18
 Cup forceps 4/15

D

DAVIS & GEEK grasping forceps 3/15
 DEBAKEY clamps 3/16, 3/21, 11/9
 DEBAKEY COOLEY forceps 11/7
 Delphin grasping forceps
 3/10, 10/11-10/12
 Delta grasper 6/16
 DENNIS dissector 11/3
 Dilatation sleeve 2/18-2/19
 Dilation set 2/2
 Dissecting forceps 3/8, 10/9-10/10

Dissecting scissors 4/9
 DORSEY (JOHANN) intestinal
 grasping forceps 3/14
 DORSEY intestinal grasping
 forceps 3/16, 3/20
 Drap door valve trocar
 sleeve 2/4, 2/6, 2/10, 2/12
 Duck bill-forceps 3/9
 DUVAL clamp 11/11

E

Electrode adapter 6/5
 Electrode handle 6/4
 Electrodes 6/1-6/4, 6/6, 6/10-6/11,
 10/20, 11/12, 12/16
 Endo-retractor 9/2-9/4
 Endoscope 1/4, 14/2
 Endoscope basket 1/6
 Endoscopic bulldog clamps 5/19
 Suction Irrigation tubes 10/24, 10/26
 Extracting forceps 3/14

F

Fallopian tube grasping
 forceps 3/11, 3/24 - 3/25
 Fascial-closure 5/15
 Fluid pump for hysteroscopy 16/13

G

GOLDFINGER retractors 9/5
 Grasping forceps 3/9-17, 3/19-20,
 6/12, 6/16, 6/19, 10/9-10/12

H

Handles 3/2-3/4, 4/3-4/5,
 5/2-5/4, 6/4, 10/6-10/8
 HARKEN clamps 11/8
 HASSON automatic trocar sleeve 2/20,
 10/3
 HIRSCH bipolar coagulation
 forceps 6/12-13
 Hook electrode 6/6, 6/11
 Hook scissors 4/10, 10/14
 Hysteroscopy forceps 12/11

I

Injection needle 11/13
 Insufflator 17/2-17/3, 17/6-17/7,
 17/10-17/11-13
 Insufflation cannula 7/9-7/10

K

Keyboard 15/6
 KLEPPINGER bipolar coagulation
 forceps 6/13
 Knot guide 5/14
 Knot pusher 5/14
 Knot tier 5/14
 KOCHER clamp 3/21

L

Lanzette electrode 6/6
 Laparoscopes 1/1, 10/1
 HASSON trocar sleeve 10/3
 Laparoscopic trocar sleeves 12/2
 Needle holders 10/17

Laparoscopy Instruments 3/7, 4/8, 5/7
 Light sources 15/3, 15/5, 15/16-15/22
 Lever retractor 9/2
 Light guide cables 14/1
 LOWSLEY retractor 13/1
 Lung grasping clamps 11/11
 FOERSTER lung grasping clamps 11/4

M

MAHNES grasping forceps 3/11-12
 MARYLAND bipolar coagulation
 scissors 6/14
 MARYLAND dissector 6/16, 6/19
 MARYLAND grasping
 forceps 3/8, 3/18-19, 10/9-10/10
 MAYO operating scissors 4/11
 Monitors 18/2-18/4
 METZENBAUM scissors 4/9, 6/13-14,
 10/13
 Micro scissors 4/10, 10/14
 MIXTER grasping forceps 3/15-16, 3/20
 Monopolar connecting cables 6/7, 12/16
 Monopolar dissection electrodes 6/3-4
 Monopolar electrode 6/1, 6/6,
 10/20, 11/12
 Multi-indication pump 16/2-16/3-16/5,
 10/2, 12/2
 MYOMA drill 12/13

N

Needle electrode 6/6, 6/11
 Needle holders 5/9-5/11, 10/17-10/19
 Needle holders, ring handle 11/10
 Nut stopper 3/1, 4/2, 5/1

O

Obturator 12/6, 12/9-12/10
 Operating-laparoscopes 1/2-1/3
 Operation sheaths 12/4
 OVERHOLT clamp 3/23

P

Palpation probes 9/1, 10/21
 PE forceps 12/11
 PENNINGTON clamp 3/22
 Peritoneal scissors 4/10, 10/13
 Pistol handle 6/5, 7/6
 Protection cap 3/2, 4/4, 5/3, 10/7
 Protection trocar 2/3, 2/5, 2/9, 2/11, 2/15
 Pump systems for arthroscopy 16/8-16/9
 Pump systems for hysteroscopy 16/12
 Pump systems for laparoscopy 16/10
 Pump systems for urology 16/11
 Punction needle sucker 7/3
 Puncture & injection needle 7/8, 10/23
 Puncture tube 7/8

R

Reducer sleeve
 2/3, 2/8, 2/11, 2/14, 2/18, 2/19
 Ring applicator 12/12
 ROMEO needle holder 5/12
 Round hole sucker 7/3
 Round hole-bee hive
 Sucker 7/3

INSTRUMENTE GMBH

Rubber washer.....2/2, 2/4, 2/6, 2/8, 2/10,
..... 2/12, 2/14, 2/16, 2/18, 2/19

S

S retractor..... 2/1
Safety handles.....6/1-6/2
Safety trocars..... 2/3, 2/5, 2/7, 2/9,
..... 2/11, 2/13, 2/15, 2/17, 10/2
Scissors6/16, 6/19, 12/11
Sheaths.....12/3-12/10
Silicone valve trocar sleeve2/4, 2/6,
..... 2/10, 2/12
Spatula electrode..... 6/6
Speculum retractor..... 9/6
STERN chest tube passer11/6
Storage rack..... 1/6
STUMP bee hive sucker.....7/3
STUMP sucker7/3
Suction irrigation cannulas.....7/1-7/2,
..... 10/22-10/23
Suction irrigation handles.....7/3, 7/5-7/7,
.....10/25-10/26, 11/13
Suction irrigation tubes ... 7/2-7/3, 7/5-7/7,
.....10/24, 11/13
Suture instrument.....5/13

T

Tenaculum forceps..... 3/18, 3/23
Thoracoscope..... 11/1
Thorax trocar sleeves.....11/2
Tissue grasper..... 3/24 - 3/25
Trocars..... 2/3, 2/5, 2/7, 2/9,
..... 2/11, 2/13, 2/15, 2/17, 2/18, 2/19,
.....2/20, 10/2-10/3, 12/2
Trocar sleeves.....2/2, 2/4, 2/6, 2/8, 2/10,
..... 2/12, 2/14, 2/16, 2/18-2/19, 10/2
Trolley18/4
Trumpet valve with electrode
adapter..... 6/5

U

Universal grasping
forceps..... 3/8, 10/9-10/10
Uterine cannula12/14
Uterus manipulator12/15
Uterus obturator12/15

V

V-shaped electrode6/11
Veress insufflation cannula.....7/10

W

Wire basket..... 1/6

Z

Zoom coupler15/6

89256-46.....	1/6	R019-9317.....	1/6	R020-110101-051.....	2/11	R025-100097-001.....	2/8
89257-46.....	1/6	R019-9321.....	1/6	R020-110101-052.....	2/11	R025-110101-001.....	2/10
89258-47.....	1/6	R019-9331.....	1/6	R020-110150-001.....	2/13	R025-110101-003.....	2/10
89450-50.....	1/6	R020-000000-007.....	2/1	R020-110150-002.....	2/13	R025-110105-002.....	2/10
96000-03.....	3/26	R020-000000-010.....	2/1	R020-110150-011.....	2/13	R025-110105-004.....	2/10
96000-05.....	3/26	R020-000000-013.....	2/1	R020-110150-051.....	2/13	R025-110150-001.....	2/12
96000-07.....	3/26	R020-000000-016.....	2/1	R020-110150-052.....	2/13	R025-125098-001.....	2/14
96000-12.....	3/26	R020-035070-001.....	10/2	R020-110500-001.....	2/20	R025-125098-003.....	2/14
98002-06.....	1/5	R020-035070-002.....	10/2	R020-110700-001.....	2/20	R025-125102-002.....	2/14
R032M-000 000-000.....	10/9	R020-035070-003.....		R020-125000-011.....	2/14, 2/16	R025-125102-004.....	2/14
R033-000 000-000.....	10/9	10/2-10/3, 2/20	R020-125035-001.....	2/14	R025-125150-001.....	2/16
R033P-000 000-000.....	10/9	R020-035070-023.....	10/2	R020-125098-001.....	2/15	R025-150095-011.....	2/18
R034-000 000-000.....	10/9	R020-035500-001.....		R020-125098-002.....	2/15	R025-200095-011.....	2/19
R037-000 000-000.....	10/10	10/3, 2/20	R020-125098-003.....	2/20	R026-055030-003.....	2/3
R038-000 000-000.....	10/10	R020-050000-004.....		R020-125098-011.....	2/15	R026-100055-002.....	2/8
R 516.07.....	1/7	2/2, 2/4, 2/6	R020-125098-016.....	2/15	R026-100055-003.....	2/8
R 516.08.....	1/7	R020-050035-001.....	2/2	R020-125098-024.....	2/15	R026-110055-002.....	2/11
R 517.07.....	1/7	R020-050092-001.....	2/3	R020-125098-025.....	2/15	R026-110055-003.....	2/11
R 517.08.....	1/7	R020-050092-002.....	2/3	R020-125098-028.....	2/15	R026-125055-002.....	2/14
R 526.07.....	1/7	R020-050092-011.....	2/3	R020-125098-051.....	2/15	R026-125055-003.....	2/14
R 526.08.....	1/7	R020-050092-016.....	2/3	R020-125098-052.....	2/15	R026-125055-004.....	2/11, 2/14
R 527.07.....	1/7	R020-050092-024.....	2/3	R020-125150-001.....	2/17	R026-125100-002.....	2/14
R 527.08.....	1/7	R020-050092-025.....	2/3	R020-125150-002.....	2/17	R026-125100-004.....	2/14
R 536.07.....	1/7	R020-050092-051.....	2/3	R020-125150-011.....	2/17	R026-150055-003.....	2/18, 2/19
R 536.08.....	1/7	R020-050092-052.....	2/3	R020-125150-051.....	2/17	R026-150100-003.....	2/18, 2/19
R 537.07.....	1/7	R020-055035-001.....	2/4	R020-125150-052.....	2/17	R027-050100-000.....	2/2
R 537.08.....	1/7	R020-055095-001.....	2/5	R020-125500-001.....	2/20	R027-050110-000.....	2/2
R 546.07.....	1/7	R020-055095-002.....	2/5	R020-150000-013.....	2/18	R027-050150-000.....	2/18
R 546.08.....	1/7	R020-055095-003.....	2/20	R020-150096-001.....	2/18	R027-050200-000.....	2/19
R 547.07.....	1/7	R020-055095-011.....	2/5	R020-150096-002.....	2/18	R027-110150-000.....	2/18
R 547.08.....	1/7	R020-055095-016.....	2/5	R020-200000-018.....	2/19	R027-110200-000.....	2/19
R 556.07.....	1/7	R020-055095-024.....	2/5	R020-200096-001.....	2/19	R028-055095-021.....	2/20
R 556.08.....	1/7	R020-055095-025.....	2/5	R020-200096-002.....	2/19	R028-110101-021.....	2/20
R 557.07.....	1/7	R020-055095-028.....	2/5	R022-050000-000.....	2/2	R028-125098-021.....	2/20
R 557.08.....	1/7	R020-055095-051.....	2/5	R022-055000-000.....	2/4, 2/6	R030-000000.....	3/2, 4/3,
R 566.07.....	1/7	R020-055095-052.....	2/5	R022-055095-001.....	2/4	5/3, 10/7
R 566.08.....	1/7	R020-055150-001.....	2/7	R022-055095-003.....	2/4	R030-050330-000.....	3/7, 4/9,
R 567.07.....	1/7	R020-055150-002.....	2/7	R022-055098-002.....	2/4	5/7
R 567.08.....	1/7	R020-055150-011.....	2/7	R022-055098-004.....	2/4	R030-050330-000L.....	3/7, 4/9,
R 614.08.....	1/7	R020-055150-051.....	2/7	R022-055150-001.....	2/6	5/7
R 614.10.....	1/7	R020-055150-052.....	2/7	R022-100000-000.....	2/8	R030-050360-000.....	3/7, 4/9,
R 624.08.....	1/7	R020-055500-001.....	2/20	R022-110000-000.....	2/10, 2/12	5/7
R 624.10.....	1/7	R020-070095-001.....	12/2	R022-110101-001.....	2/10	R030-050360-000L.....	3/7, 4/9,
R 634.08.....	1/7	R020-070095-002.....	12/2	R022-110101-003.....	2/10	5/7
R 634.10.....	1/7	R020-100000-008.....	2/8	R022-110105-002.....	2/10	R030-050450-000.....	3/7, 4/9,
R 644.08.....	1/7	R020-100035-001.....	2/8	R022-110105-004.....	2/10	5/7
R 644.10.....	1/7	R020-100097-001.....	2/9	R022-110150-001.....	2/12	R030-050450-000L.....	3/7, 4/9,
R 654.08.....	1/7	R020-100097-002.....	2/9	R022-125000-000.....	2/14, 2/16	5/7
R 654.10.....	1/7	R020-100097-011.....	2/9	R022-150000-000.....	2/18	R030-100330-000.....	3/7, 4/9,
R 664.08.....	1/7	R020-100097-016.....	2/9	R022-200000-000.....	2/19	5/7
R 664.10.....	1/7	R020-100097-024.....	2/9	R023-035070-001.....	10/2	R030-100330-0005.....	3/7, 4/9,
R010-020187-000.....	10/1	R020-100097-025.....	2/9	R023-070095-001.....	12/2	5/7
R010-050302-000.....	1/1	R020-100097-051.....	2/9	R024-055095-001.....	2/4	R030-100360-000.....	3/7, 4/9,
R010-050302-030.....	1/1	R020-100097-052.....	2/9	R024-055150-001.....	2/6	5/7
R010-100309-000.....	1/1	R020-110000-009.....	2/10, 2/12	R024-110101-001.....	2/10	R030-100360-0005.....	3/7, 4/9,
R010-100309-030.....	1/1	R020-110035-001.....	2/10	R024-110101-003.....	2/10	5/7
R010-100350-000.....	1/1	R020-110101-001.....	2/11	R024-110105-002.....	2/10	R030-100450-000.....	3/7, 4/9,
R010-100350-030.....	1/1	R020-110101-002.....	2/11	R024-110105-004.....	2/10	5/7
R011-100273-060.....	1/2	R020-110101-003.....	2/20	R024-110150-001.....	2/12	R030-100450-0005.....	3/7, 4/9,
R012-100273-060.....	1/3	R020-110101-011.....	2/11	R025-055095-001.....	2/4	5/7
R019-000000-01.....	1/4	R020-110101-016.....	2/11	R025-055095-003.....	2/4	R030-050330-210.....	3/8
R019-000000-02.....	1/4	R020-110101-024.....	2/11	R025-055098-002.....	2/4	R030-050330-212.....	3/8
R019-000000-025.....	1/5	R020-110101-025.....	2/11	R025-055098-004.....	2/4	R030-050330-213.....	3/8
R019-000000-030.....	1/5	R020-110101-028.....	2/11	R025-055150-001.....	2/6	R030-050330-214.....	3/8

R030-050330-215.....3/9	R030-050360-248.....3/14	R030-100330-623.....3/21	R032M-050330-246.....3/14
R030-050330-216.....3/9	R030-050360-249.....3/14	R030-100330-624.....3/21	R032M-050330-248.....3/14
R030-050330-217.....3/18	R030-050360-250.....3/15	R030-100330-631.....3/21	R032M-050330-249.....3/14
R030-050330-218.....3/9	R030-050360-251.....3/15	R030-100330-632.....3/21	R032M-050330-250.....3/15
R030-050330-219.....3/9	R030-050360-252.....3/15	R030-100330-633.....3/21	R032M-050330-251.....3/15
R030-050330-220.....3/10	R030-050360-258.....3/15	R030-100330-642.....3/20	R032M-050330-252.....3/15
R030-050330-224.....3/10	R030-050360-259.....3/16	R030-100330-646.....3/20	R032M-050330-258.....3/15
R030-050330-225.....3/10	R030-050360-262.....3/16	R030-100330-648.....3/20	R032M-050330-259.....3/16
R030-050330-226.....3/11	R030-050360-264.....3/16	R030-100330-650.....3/22	R032M-050330-262.....3/16
R030-050330-228.....3/11	R030-050360-266.....3/16	R030-100330-654.....3/23	R032M-050330-264.....3/16
R030-050330-230.....3/11	R030-050360-270.....3/17	R030-100330-656.....3/23	R032M-050330-266.....3/16
R030-050330-231.....3/11	R030-050360-272.....3/17	R030-100360-610.....3/19	R032M-050330-270.....3/17
R030-050330-232.....3/12	R030-050360-274.....3/17	R030-100360-612.....3/19	R032M-050330-272.....3/17
R030-050330-234.....3/12	R030-050360-276.....3/17	R030-100360-614.....3/19	R032M-050330-274.....3/17
R030-050330-236.....3/12	R030-050360-284.....3/18	R030-100360-616.....3/20	R032M-050330-276.....3/17
R030-050330-238.....3/12	R030-050450-210.....3/8	R030-100360-618.....3/22	R032M-050330-284.....3/18
R030-050330-240.....3/13	R030-050450-212.....3/8	R030-100360-620.....3/22	R032M-050360-210.....3/8
R030-050330-241.....3/13	R030-050450-213.....3/8	R030-100360-622.....3/21	R032M-050360-212.....3/8
R030-050330-242.....3/13	R030-050450-214.....3/8	R030-100360-623.....3/21	R032M-050360-213.....3/8
R030-050330-243.....3/13	R030-050450-215.....3/9	R030-100360-624.....3/21	R032M-050360-214.....3/8
R030-050330-244.....3/14	R030-050450-216.....3/9	R030-100360-631.....3/21	R032M-050360-215.....3/9
R030-050330-246.....3/14	R030-050450-217.....3/18	R030-100360-632.....3/21	R032M-050360-216.....3/9
R030-050330-248.....3/14	R030-050450-218.....3/9	R030-100360-633.....3/21	R032M-050360-217.....3/18
R030-050330-249.....3/14	R030-050450-219.....3/9	R030-100360-642.....3/20	R032M-050360-219.....3/9
R030-050330-250.....3/15	R030-050450-220.....3/10	R030-100360-646.....3/20	R032M-050360-220.....3/10
R030-050330-251.....3/15	R030-050450-222.....3/10	R030-100360-648.....3/20	R032M-050360-222.....3/10
R030-050330-252.....3/15	R030-050450-224.....3/10	R030-100360-650.....3/22	R032M-050360-224.....3/10
R030-050330-258.....3/15	R030-050450-225.....3/10	R030-100360-654.....3/23	R032M-050360-225.....3/10
R030-050330-259.....3/16	R030-050450-226.....3/11	R030-100360-656.....3/23	R032M-050360-226.....3/11
R030-050330-262.....3/16	R030-050450-228.....3/11	R030-100450-610.....3/19	R032M-050360-228.....3/11
R030-050330-264.....3/16	R030-050450-230.....3/11	R030-100450-612.....3/19	R032M-050360-230.....3/11
R030-050330-266.....3/16	R030-050450-231.....3/11	R030-100450-614.....3/19	R032M-050360-231.....3/11
R030-050330-270.....3/17	R030-050450-232.....3/12	R030-100450-616.....3/20	R032M-050360-232.....3/12
R030-050330-272.....3/17	R030-050450-234.....3/12	R030-100450-642.....3/20	R032M-050360-234.....3/12
R030-050330-274.....3/17	R030-050450-236.....3/12	R030-100450-646.....3/20	R032M-050360-236.....3/12
R030-050330-276.....3/17	R030-050450-238.....3/12	R030-100450-648.....3/20	R032M-050360-238.....3/12
R030-050330-284.....3/18	R030-050450-240.....3/13	R030-100450-648.....3/20	R032M-050360-238.....3/12
R030-050360-210.....3/8	R030-050450-241.....3/13	R032M-000000-000.....3/2,4/3, 5/2, 10/6	R032M-050360-240.....3/13
R030-050360-212.....3/8	R030-050450-242.....3/13	R032M-050330-210.....3/8	R032M-050360-241.....3/13
R030-050360-213.....3/8	R030-050450-243.....3/13	R032M-050330-212.....3/8	R032M-050360-242.....3/13
R030-050360-214.....3/8	R030-050450-244.....3/14	R032M-050330-213.....3/8	R032M-050360-243.....3/13
R030-050360-215.....3/9	R030-050450-246.....3/14	R032M-050330-214.....3/8	R032M-050360-244.....3/14
R030-050360-216.....3/9	R030-050450-248.....3/14	R032M-050330-215.....3/9	R032M-050360-246.....3/14
R030-050360-217.....3/18	R030-050450-249.....3/14	R032M-050330-216.....3/9	R032M-050360-248.....3/14
R030-050360-218.....3/9	R030-050450-250.....3/15	R032M-050330-217.....3/18	R032M-050360-249.....3/14
R030-050360-219.....3/9	R030-050450-251.....3/15	R032M-050330-218.....3/9	R032M-050360-250.....3/15
R030-050360-220.....3/10	R030-050450-252.....3/15	R032M-050330-219.....3/9	R032M-050360-251.....3/15
R030-050360-222.....3/10	R030-050450-258.....3/15	R032M-050330-220.....3/10	R032M-050360-252.....3/15
R030-050360-224.....3/10	R030-050450-259.....3/16	R032M-050330-222.....3/10	R032M-050360-258.....3/15
R030-050360-225.....3/10	R030-050450-262.....3/16	R032M-050330-224.....3/10	R032M-050360-259.....3/16
R030-050360-226.....3/11	R030-050450-264.....3/16	R032M-050330-225.....3/10	R032M-050360-262.....3/16
R030-050360-228.....3/11	R030-050450-266.....3/16	R032M-050330-226.....3/11	R032M-050360-264.....3/16
R030-050360-230.....3/11	R030-050450-270.....3/17	R032M-050330-228.....3/11	R032M-050360-266.....3/16
R030-050360-231.....3/11	R030-050450-272.....3/17	R032M-050330-230.....3/11	R032M-050360-270.....3/17
R030-050360-232.....3/12	R030-050450-274.....3/17	R032M-050330-231.....3/11	R032M-050360-272.....3/17
R030-050360-234.....3/12	R030-050450-276.....3/17	R032M-050330-232.....3/12	R032M-050360-274.....3/17
R030-050360-236.....3/12	R030-050450-284.....3/18	R032M-050330-233.....3/12	R032M-050360-276.....3/17
R030-050360-238.....3/12	R030-100330-610.....3/19	R032M-050330-234.....3/12	R032M-050360-284.....3/18
R030-050360-240.....3/13	R030-100330-612.....3/19	R032M-050330-236.....3/12	R032M-050450-210.....3/8
R030-050360-241.....3/13	R030-100330-614.....3/19	R032M-050330-238.....3/12	R032M-050450-212.....3/8
R030-050360-242.....3/13	R030-100330-616.....3/20	R032M-050330-240.....3/13	R032M-050450-213.....3/8
R030-050360-243.....3/13	R030-100330-618.....3/22	R032M-050330-241.....3/13	R032M-050450-214.....3/8
R030-050360-244.....3/14	R030-100330-620.....3/22	R032M-050330-242.....3/13	R032M-050450-215.....3/9
R030-050360-246.....3/14	R030-100330-622.....3/21	R032M-050330-243.....3/13	R032M-050450-216.....3/9
		R032M-050330-244.....3/14	R032M-050450-217.....3/18

R032M-050450-218.....	3/9	R032M-100360-633.....	3/21	R033-050360-217.....	3/18	R033-050450-249.....	3/14
R032M-050450-219.....	3/9	R032M-100360-642.....	3/20	R033-050360-218.....	3/9	R033-050450-250.....	3/15
R032M-050450-220.....	3/10	R032M-100360-646.....	3/20	R033-050360-219.....	3/9	R033-050450-251.....	3/15
R032M-050450-222.....	3/10	R032M-100360-648.....	3/20	R033-050360-220.....	3/10	R033-050450-252.....	3/15
R032M-050450-224.....	3/10	R032M-100360-650.....	3/22	R033-050360-222.....	3/10	R033-050450-258.....	3/15
R032M-050450-225.....	3/10	R032M-100360-654.....	3/23	R033-050360-224.....	3/10	R033-050450-259.....	3/16
R032M-050450-226.....	3/11	R032M-100360-656.....	3/23	R033-050360-225.....	3/10	R033-050450-262.....	3/16
R032M-050450-228.....	3/11	R032M-100450-610.....	3/19	R033-050360-226.....	3/11	R033-050450-264.....	3/16
R032M-050450-230.....	3/11	R032M-100450-612.....	3/19	R033-050360-228.....	3/11	R033-050450-266.....	3/16
R032M-050450-231.....	3/11	R032M-100450-614.....	3/19	R033-050360-230.....	3/11	R033-050450-270.....	3/17
R032M-050450-232.....	3/12	R032M-100450-616.....	3/20	R033-050360-231.....	3/11	R033-050450-272.....	3/17
R032M-050450-234.....	3/12	R032M-100450-642.....	3/20	R033-050360-232.....	3/12	R033-050450-274.....	3/17
R032M-050450-236.....	3/12	R032M-100450-646.....	3/20	R033-050360-234.....	3/12	R033-050450-276.....	3/17
R032M-050450-238.....	3/12	R032M-100450-648.....	3/20	R033-050360-236.....	3/12	R033-050450-284.....	3/18
R032M-050450-240.....	3/13	R033-000000-000.....	3/2, 4/3, 5/2, 10/6	R033-050360-238.....	3/12	R033-100330-610.....	3/19
R032M-050450-241.....	3/13			R033-050360-240.....	3/13	R033-100330-612.....	3/19
R032M-050450-242.....	3/13	R033-050330-210.....	3/8	R033-050360-241.....	3/13	R033-100330-614.....	3/19
R032M-050450-243.....	3/13	R033-050330-212.....	3/8	R033-050360-242.....	3/13	R033-100330-616.....	3/20
R032M-050450-244.....	3/14	R033-050330-213.....	3/8	R033-050360-243.....	3/13	R033-100330-618.....	3/22
R032M-050450-246.....	3/14	R033-050330-214.....	3/8	R033-050360-244.....	3/14	R033-100330-620.....	3/22
R032M-050450-248.....	3/14	R033-050330-215.....	3/9	R033-050360-246.....	3/14	R033-100330-622.....	3/21
R032M-050450-249.....	3/14	R033-050330-216.....	3/9	R033-050360-248.....	3/14	R033-100330-623.....	3/21
R032M-050450-250.....	3/15	R033-050330-217.....	3/18	R033-050360-249.....	3/14	R033-100330-624.....	3/21
R032M-050450-251.....	3/15	R033-050330-218.....	3/9	R033-050360-250.....	3/15	R033-100330-631.....	3/21
R032M-050450-252.....	3/15	R033-050330-219.....	3/9	R033-050360-251.....	3/15	R033-100330-632.....	3/21
R032M-050450-258.....	3/15	R033-050330-220.....	3/10	R033-050360-252.....	3/15	R033-100330-633.....	3/21
R032M-050450-259.....	3/16	R033-050330-222.....	3/10	R033-050360-258.....	3/15	R033-100330-642.....	3/20
R032M-050450-262.....	3/16	R033-050330-224.....	3/10	R033-050360-259.....	3/16	R033-100330-646.....	3/20
R032M-050450-264.....	3/16	R033-050330-225.....	3/10	R033-050360-262.....	3/16	R033-100330-648.....	3/20
R032M-050450-266.....	3/16	R033-050330-226.....	3/11	R033-050360-264.....	3/16	R033-100330-650.....	3/22
R032M-050450-270.....	3/17	R033-050330-228.....	3/11	R033-050360-266.....	3/16	R033-100330-654.....	3/23
R032M-050450-272.....	3/17	R033-050330-230.....	3/11	R033-050360-270.....	3/17	R033-100330-656.....	3/23
R032M-050450-274.....	3/17	R033-050330-231.....	3/11	R033-050360-272.....	3/17	R033-100360-610.....	3/19
R032M-050450-276.....	3/17	R033-050330-232.....	3/12	R033-050360-274.....	3/17	R033-100360-612.....	3/19
R032M-050450-284.....	3/18	R033-050330-234.....	3/12	R033-050360-276.....	3/17	R033-100360-614.....	3/19
R032M-100330-610.....	3/19	R033-050330-236.....	3/12	R033-050360-284.....	3/18	R033-100360-616.....	3/20
R032M-100330-612.....	3/19	R033-050330-238.....	3/12	R033-050450-210.....	3/8	R033-100360-618.....	3/22
R032M-100330-614.....	3/19	R033-050330-240.....	3/13	R033-050450-212.....	3/8	R033-100360-620.....	3/22
R032M-100330-616.....	3/20	R033-050330-241.....	3/13	R033-050450-213.....	3/8	R033-100360-622.....	3/21
R032M-100330-618.....	3/22	R033-050330-242.....	3/13	R033-050450-214.....	3/8	R033-100360-623.....	3/21
R032M-100330-620.....	3/22	R033-050330-243.....	3/13	R033-050450-215.....	3/9	R033-100360-624.....	3/21
R032M-100330-622.....	3/21	R033-050330-244.....	3/14	R033-050450-216.....	3/9	R033-100360-631.....	3/21
R032M-100330-623.....	3/21	R033-050330-246.....	3/14	R033-050450-217.....	3/18	R033-100360-632.....	3/21
R032M-100330-624.....	3/21	R033-050330-248.....	3/14	R033-050450-218.....	3/9	R033-100360-633.....	3/21
R032M-100330-631.....	3/21	R033-050330-249.....	3/14	R033-050450-219.....	3/9	R033-100360-642.....	3/20
R032M-100330-632.....	3/21	R033-050330-250.....	3/15	R033-050450-220.....	3/10	R033-100360-646.....	3/20
R032M-100330-633.....	3/21	R033-050330-251.....	3/15	R033-050450-222.....	3/10	R033-100360-648.....	3/20
R032M-100330-642.....	3/20	R033-050330-252.....	3/15	R033-050450-224.....	3/10	R033-100360-650.....	3/22
R032M-100330-646.....	3/20	R033-050330-258.....	3/15	R033-050450-225.....	3/10	R033-100360-654.....	3/23
R032M-100330-648.....	3/20	R033-050330-259.....	3/16	R033-050450-226.....	3/11	R033-100360-656.....	3/23
R032M-100330-650.....	3/22	R033-050330-262.....	3/16	R033-050450-228.....	3/11	R033-100450-610.....	3/19
R032M-100330-654.....	3/23	R033-050330-264.....	3/16	R033-050450-230.....	3/11	R033-100450-612.....	3/19
R032M-100330-656.....	3/23	R033-050330-266.....	3/16	R033-050450-231.....	3/11	R033-100450-614.....	3/19
R032M-100360-610.....	3/19	R033-050330-270.....	3/17	R033-050450-232.....	3/12	R033-100450-616.....	3/20
R032M-100360-612.....	3/19	R033-050330-272.....	3/17	R033-050450-234.....	3/12	R033-100450-642.....	3/20
R032M-100360-614.....	3/19	R033-050330-274.....	3/17	R033-050450-236.....	3/12	R033-100450-646.....	3/20
R032M-100360-616.....	3/20	R033-050330-276.....	3/17	R033-050450-238.....	3/12	R033-100450-648.....	3/20
R032M-100360-618.....	3/22	R033-050330-284.....	3/18	R033-050450-240.....	3/13	R033M-000000-000.....	3/2, 4/3, 5/3, 10/7
R032M-100360-620.....	3/22	R033-050360-210.....	3/8	R033-050450-241.....	3/13	R033P-000000-000.....	3/2, 4/3, 5/2, 10/6
R032M-100360-622.....	3/21	R033-050360-212.....	3/8	R033-050450-242.....	3/13	R033P-050330-210.....	3/8
R032M-100360-623.....	3/21	R033-050360-213.....	3/8	R033-050450-243.....	3/13	R033P-050330-212.....	3/8
R032M-100360-624.....	3/21	R033-050360-214.....	3/8	R033-050450-244.....	3/14	R033P-050330-213.....	3/8
R032M-100360-631.....	3/21	R033-050360-215.....	3/9	R033-050450-246.....	3/14		
R032M-100360-632.....	3/21	R033-050360-216.....	3/9	R033-050450-248.....	3/14		

R033P-050330-2143/8	R033P-050360-2443/14	R033P-100330-6203/22	R034-050330-2433/13
R033P-050330-2153/9	R033P-050360-2463/14	R033P-100330-6223/21	R034-050330-2443/14
R033P-050330-2163/9	R033P-050360-2483/14	R033P-100330-6233/21	R034-050330-2463/14
R033P-050330-2173/18	R033P-050360-2493/14	R033P-100330-6243/21	R034-050330-2483/14
R033P-050330-2183/9	R033P-050360-2503/15	R033P-100330-6313/21	R034-050330-2493/14
R033P-050330-2193/9	R033P-050360-2513/15	R033P-100330-6323/21	R034-050330-2503/15
R033P-050330-2203/10	R033P-050360-2523/15	R033P-100330-6333/21	R034-050330-2513/15
R033P-050330-2223/10	R033P-050360-2583/15	R033P-100330-6423/20	R034-050330-2523/15
R033P-050330-2243/10	R033P-050360-2593/16	R033P-100330-6463/20	R034-050330-2583/15
R033P-050330-2253/10	R033P-050360-2623/16	R033P-100330-6483/20	R034-050330-2593/16
R033P-050330-2263/11	R033P-050360-2643/16	R033P-100330-6503/22	R034-050330-2623/16
R033P-050330-2283/11	R033P-050360-2663/16	R033P-100330-6543/23	R034-050330-2643/16
R033P-050330-2303/11	R033P-050360-2703/17	R033P-100330-6563/23	R034-050330-2663/16
R033P-050330-2313/11	R033P-050360-2723/17	R033P-100360-6103/19	R034-050330-2703/17
R033P-050330-2323/12	R033P-050360-2743/17	R033P-100360-6123/19	R034-050330-2723/17
R033P-050330-2343/12	R033P-050360-2763/17	R033P-100360-6143/19	R034-050330-2743/17
R033P-050330-2363/12	R033P-050360-2843/18	R033P-100360-6163/20	R034-050330-2763/17
R033P-050330-2383/12	R033P-050450-2103/8	R033P-100360-6183/22	R034-050330-2843/18
R033P-050330-2403/13	R033P-050450-2123/8	R033P-100360-6203/22	R034-050360-2103/8
R033P-050330-2413/13	R033P-050450-2133/8	R033P-100360-6223/21	R034-050360-2123/8
R033P-050330-2423/13	R033P-050450-2143/8	R033P-100360-6233/21	R034-050360-2133/8
R033P-050330-2433/13	R033P-050450-2153/9	R033P-100360-6243/21	R034-050360-2143/8
R033P-050330-2443/14	R033P-050450-2163/9	R033P-100360-6313/21	R034-050360-2153/9
R033P-050330-2463/14	R033P-050450-2173/18	R033P-100360-6323/21	R034-050360-2163/9
R033P-050330-2483/14	R033P-050450-2183/9	R033P-100360-6333/21	R034-050360-2173/18
R033P-050330-2493/14	R033P-050450-2193/9	R033P-100360-6423/20	R034-050360-2183/9
R033P-050330-2503/15	R033P-050450-2203/10	R033P-100360-6463/20	R034-050360-2193/9
R033P-050330-2513/15	R033P-050450-2223/10	R033P-100360-6483/20	R034-050360-2203/10
R033P-050330-2523/15	R033P-050450-2243/10	R033P-100360-6503/22	R034-050360-2223/10
R033P-050330-2583/15	R033P-050450-2253/10	R033P-100360-6543/23	R034-050360-2243/10
R033P-050330-2593/16	R033P-050450-2263/11	R033P-100360-6563/23	R034-050360-2253/10
R033P-050330-2623/16	R033P-050450-2283/11	R033P-100450-6103/19	R034-050360-2263/11
R033P-050330-2643/16	R033P-050450-2303/11	R033P-100450-6123/19	R034-050360-2283/11
R033P-050330-2663/16	R033P-050450-2313/11	R033P-100450-6143/19	R034-050360-2303/11
R033P-050330-2703/17	R033P-050450-2323/12	R033P-100450-6163/20	R034-050360-2313/11
R033P-050330-2723/17	R033P-050450-2343/12	R033P-100450-6423/20	R034-050360-2323/12
R033P-050330-2743/17	R033P-050450-2363/12	R033P-100450-6463/20	R034-050360-2343/12
R033P-050330-2763/17	R033P-050450-2383/12	R033P-100450-6483/20	R034-050360-2363/12
R033P-050330-2843/18	R033P-050450-2403/13	R034-000000-0003/2,	R034-050360-2383/12
R033P-050360-2103/8	R033P-050450-2413/134/3, 5/2, 10/6	R034-050360-2403/13
R033P-050360-2123/8	R033P-050450-2423/13	R034-050330-2103/8	R034-050360-2413/13
R033P-050360-2133/8	R033P-050450-2433/13	R034-050330-2123/8	R034-050360-2423/13
R033P-050360-2143/8	R033P-050450-2443/14	R034-050330-2133/8	R034-050360-2433/13
R033P-050360-2153/9	R033P-050450-2463/14	R034-050330-2143/8	R034-050360-2443/14
R033P-050360-2163/9	R033P-050450-2483/14	R034-050330-2153/9	R034-050360-2463/14
R033P-050360-2173/18	R033P-050450-2493/14	R034-050330-2163/9	R034-050360-2483/14
R033P-050360-2183/9	R033P-050450-2503/15	R034-050330-2173/18	R034-050360-2493/14
R033P-050360-2193/9	R033P-050450-2513/15	R034-050330-2183/9	R034-050360-2503/15
R033P-050360-2203/10	R033P-050450-2523/15	R034-050330-2193/9	R034-050360-2513/15
R033P-050360-2223/10	R033P-050450-2583/15	R034-050330-2203/10	R034-050360-2523/15
R033P-050360-2243/10	R033P-050450-2593/16	R034-050330-2223/10	R034-050360-2583/15
R033P-050360-2253/10	R033P-050450-2623/16	R034-050330-2243/10	R034-050360-2593/16
R033P-050360-2263/11	R033P-050450-2643/16	R034-050330-2253/10	R034-050360-2623/16
R033P-050360-2283/11	R033P-050450-2663/16	R034-050330-2263/11	R034-050360-2643/16
R033P-050360-2303/11	R033P-050450-2703/17	R034-050330-2283/11	R034-050360-2663/16
R033P-050360-2313/11	R033P-050450-2723/17	R034-050330-2303/11	R034-050360-2703/17
R033P-050360-2323/12	R033P-050450-2743/17	R034-050330-2313/11	R034-050360-2723/17
R033P-050360-2343/12	R033P-050450-2763/17	R034-050330-2323/12	R034-050360-2743/17
R033P-050360-2363/12	R033P-050450-2843/18	R034-050330-2343/12	R034-050360-2763/17
R033P-050360-2383/12	R033P-100330-6103/19	R034-050330-2363/12	R034-050360-2843/18
R033P-050360-2403/13	R033P-100330-6123/19	R034-050330-2383/12	R034-050450-2103/8
R033P-050360-2413/13	R033P-100330-6143/19	R034-050330-2403/13	R034-050450-2123/8
R033P-050360-2423/13	R033P-100330-6163/20	R034-050330-2413/13	R034-050450-2133/8
R033P-050360-2433/13	R033P-100330-6183/22	R034-050330-2423/13	R034-050450-2143/8

R034-050450-215.....	3/9	R034-100360-624.....	3/21	R040-050360-314.....	4/12	R044-050360-410.....	4/14
R034-050450-216.....	3/9	R034-100360-631.....	3/21	R040-050360-316.....	4/13	R044-050360-412.....	4/14
R034-050450-217.....	3/18	R034-100360-632.....	3/21	R040-050360-318.....	4/13	R044-050450-110.....	4/9
R034-050450-218.....	3/9	R034-100360-633.....	3/21	R040-050360-320.....	4/13	R044-050450-112.....	4/9
R034-050450-219.....	3/9	R034-100360-642.....	3/20	R040-050360-410.....	4/14	R044-050450-113.....	4/9
R034-050450-220.....	3/10	R034-100360-646.....	3/20	R040-050360-412.....	4/14	R044-050450-114.....	4/10
R034-050450-222.....	3/10	R034-100360-648.....	3/20	R040-050450-110.....	4/9	R044-050450-116.....	4/10
R034-050450-224.....	3/10	R034-100360-650.....	3/22	R040-050450-112.....	4/9	R044-050450-118.....	4/10
R034-050450-225.....	3/10	R034-100360-654.....	3/23	R040-050450-113.....	4/9	R044-050450-120.....	4/10
R034-050450-226.....	3/11	R034-100360-656.....	3/23	R040-050450-114.....	4/10	R044-050450-122.....	4/9
R034-050450-228.....	3/11	R034-100450-610.....	3/19	R040-050450-116.....	4/10	R044-050450-125.....	4/9
R034-050450-230.....	3/11	R034-100450-612.....	3/19	R040-050450-118.....	4/10	R044-050450-268.....	4/12
R034-050450-231.....	3/11	R034-100450-614.....	3/19	R040-050450-120.....	4/10	R044-050450-310.....	4/12
R034-050450-232.....	3/12	R034-100450-616.....	3/20	R040-050450-122.....	4/9	R044-050450-312.....	4/12
R034-050450-234.....	3/12	R034-100450-642.....	3/20	R040-050450-125.....	4/9	R044-050450-314.....	4/12
R034-050450-236.....	3/12	R034-100450-646.....	3/20	R040-050450-268.....	4/12	R044-050450-316.....	4/13
R034-050450-238.....	3/12	R034-100450-648.....	3/20	R040-050450-310.....	4/12	R044-050450-318.....	4/13
R034-050450-240.....	3/13	R037-000000-000.....	3/4, 4/5, 5/4, 10/8	R040-050450-312.....	4/12	R044-050450-320.....	4/13
R034-050450-241.....	3/13	R038-000000-000.....	3/4, 4/5, 5/4, 10/8	R040-050450-314.....	4/12	R044-050450-410.....	4/14
R034-050450-242.....	3/13	R039-0533-001.....	3/24	R040-050450-316.....	4/13	R044-050450-412.....	4/14
R034-050450-243.....	3/13	R039-0533-002.....	3/24	R040-050450-318.....	4/13	R044-100330-710.....	4/11
R034-050450-244.....	3/14	R039-0533-003.....	3/24	R040-050450-320.....	4/13	R044-100330-810.....	4/15
R034-050450-246.....	3/14	R039-0533-004.....	3/24	R040-050450-410.....	4/14	R044-100360-710.....	4/11
R034-050450-248.....	3/14	R039-0533-005.....	3/24	R040-050450-412.....	4/14	R044-100360-810.....	4/15
R034-050450-249.....	3/14	R039-0533-006.....	3/24	R040-100330-710.....	4/11	R044-100450-710.....	4/11
R034-050450-250.....	3/15	R039-0533-007.....	3/24	R040-100330-810.....	4/15	R044-100450-810.....	4/15
R034-050450-251.....	3/15	R039-0533-010.....	3/24	R040-100360-710.....	4/11	R047-000000-000.....	3/4, 4/5, 5/4, 10/8
R034-050450-252.....	3/15	R039-0533-013.....	3/24	R040-100360-810.....	4/15	R048-000000-000.....	3/4, 4/5, 5/4, 10/8
R034-050450-258.....	3/15	R039-0533-014.....	3/25	R040-100450-710.....	4/11	R050-028170-001.....	5/13
R034-050450-259.....	3/16	R039-0533-015.....	3/25	R040-100450-810.....	4/15	R050-050330-01.....	5/14
R034-050450-262.....	3/16	R039-0533-016.....	3/25	R044-050330-110.....	4/9	R050-050330-02.....	5/14
R034-050450-264.....	3/16	R040-000000-000.....	3/4, 4/5, 5/4, 10/8	R044-050330-112.....	4/9	R050-050330-03.....	5/14
R034-050450-266.....	3/16	R040-050330-110.....	4/9	R044-050330-113.....	4/9	R050-050330-02.....	5/14
R034-050450-270.....	3/17	R040-050330-112.....	4/9	R044-050330-114.....	4/10	R050-050330-03.....	5/14
R034-050450-272.....	3/17	R040-050330-113.....	4/9	R044-050330-116.....	4/10	R050-050330-350.....	5/10
R034-050450-274.....	3/17	R040-050330-114.....	4/10	R044-050330-118.....	4/10	R050-050330-352.....	5/10
R034-050450-276.....	3/17	R040-050330-116.....	4/10	R044-050330-120.....	4/10	R050-050330-354.....	5/10
R034-050450-284.....	3/18	R040-050330-120.....	4/10	R044-050330-122.....	4/9	R050-050330-360.....	5/10
R034-100330-610.....	3/19	R040-050330-122.....	4/9	R044-050330-125.....	4/9	R050-050340-00.....	5/15
R034-100330-612.....	3/19	R040-050330-125.....	4/9	R044-050330-268.....	4/12	R050-050360-350.....	5/10
R034-100330-614.....	3/19	R040-050330-268.....	4/12	R044-050330-310.....	4/12	R050-050360-352.....	5/10
R034-100330-616.....	3/20	R040-050330-310.....	4/12	R044-050330-312.....	4/12	R050-050360-354.....	5/10
R034-100330-618.....	3/22	R040-050330-312.....	4/12	R044-050330-314.....	4/12	R050-050360-360.....	5/10
R034-100330-620.....	3/22	R040-050330-314.....	4/12	R044-050330-316.....	4/13	R050-050450-350.....	5/10
R034-100330-622.....	3/21	R040-050330-316.....	4/13	R044-050330-318.....	4/13	R050-050450-352.....	5/10
R034-100330-623.....	3/21	R040-050330-318.....	4/13	R044-050330-320.....	4/13	R050-050450-354.....	5/10
R034-100330-624.....	3/21	R040-050330-320.....	4/13	R044-050330-410.....	4/14	R050-050450-360.....	5/10
R034-100330-631.....	3/21	R040-050330-410.....	4/14	R044-050330-412.....	4/14	R051-050330-350.....	5/10
R034-100330-632.....	3/21	R040-050330-412.....	4/14	R044-050360-110.....	4/9	R051-050330-352.....	5/10
R034-100330-633.....	3/21	R040-050360-110.....	4/9	R044-050360-112.....	4/9	R051-050330-354.....	5/10
R034-100330-642.....	3/20	R040-050360-112.....	4/9	R044-050360-114.....	4/10	R051-050330-360.....	5/10
R034-100330-646.....	3/20	R040-050360-114.....	4/10	R044-050360-116.....	4/10	R051-050360-350.....	5/10
R034-100330-648.....	3/20	R040-050360-116.....	4/10	R044-050360-118.....	4/10	R051-050360-352.....	5/10
R034-100330-650.....	3/22	R040-050360-118.....	4/10	R044-050360-120.....	4/10	R051-050360-354.....	5/10
R034-100330-654.....	3/23	R040-050360-120.....	4/10	R044-050360-122.....	4/9	R051-050360-360.....	5/10
R034-100330-656.....	3/23	R040-050360-122.....	4/9	R044-050360-125.....	4/9	R051-050450-350.....	5/10
R034-100360-610.....	3/19	R040-050360-125.....	4/9	R044-050360-268.....	4/12	R051-050450-352.....	5/10
R034-100360-612.....	3/19	R040-050360-268.....	4/12	R044-050360-310.....	4/12	R051-050450-354.....	5/10
R034-100360-614.....	3/19	R040-050360-310.....	4/12	R044-050360-312.....	4/12	R052-050330-350.....	5/10
R034-100360-616.....	3/20	R040-050360-312.....	4/12	R044-050360-314.....	4/12	R052-050330-352.....	5/10
R034-100360-618.....	3/22	R040-050360-314.....	4/12	R044-050360-316.....	4/13	R052-050330-354.....	5/10
R034-100360-620.....	3/22	R040-050360-316.....	4/13	R044-050360-318.....	4/13	R052-050330-360.....	5/10
R034-100360-622.....	3/21	R040-050360-318.....	4/13	R044-050360-320.....	4/13	R052-050360-350.....	5/10
R034-100360-623.....	3/21	R040-050360-320.....	4/13				

R052-050360-352.....	5/10	R056-050330-22.....	5/16	R057-050360-112.....	4/9	R058-050330-320.....	4/13
R052-050360-354.....	5/10	R056-050330-41.....	5/16	R057-050360-113.....	4/9	R058-050330-350.....	5/11
R052-050360-360.....	5/10	R056-050330-42.....	5/16	R057-050360-114.....	4/10	R058-050330-352.....	5/11
R052-050450-350.....	5/10	R056-100000-00.....	5/18	R057-050360-116.....	4/10	R058-050330-354.....	5/11
R052-050450-352.....	5/10	R056-100000-01.....	5/18	R057-050360-118.....	4/10	R058-050330-360.....	5/11
R052-050450-354.....	5/10	R056-100000-02.....	5/18	R057-050360-120.....	4/10	R058-050330-410.....	4/14
R052-050450-360.....	5/10	R056-100000-03.....	5/18	R057-050360-122.....	4/9	R058-050330-412.....	4/14
R053-050330-350.....	5/10	R056-100000-04.....	5/18	R057-050360-125.....	4/9	R058-050360-110.....	4/9
R053-050330-352.....	5/10	R056-100000-11.....	5/18	R057-050360-268.....	4/12	R058-050360-112.....	4/9
R053-050330-354.....	5/10	R056-100000-12.....	5/18	R057-050360-310.....	4/12	R058-050360-113.....	4/9
R053-050330-360.....	5/10	R056-100000-13.....	5/18	R057-050360-312.....	4/12	R058-050360-114.....	4/10
R053-050360-350.....	5/10	R056-100000-14.....	5/18	R057-050360-314.....	4/12	R058-050360-116.....	4/10
R053-050360-352.....	5/10	R056-100000-21.....	5/18	R057-050360-316.....	4/13	R058-050360-118.....	4/10
R053-050360-354.....	5/10	R056-100000-22.....	5/18	R057-050360-318.....	4/13	R058-050360-120.....	4/10
R053-050360-360.....	5/10	R056-100000-23.....	5/18	R057-050360-320.....	4/13	R058-050360-122.....	4/9
R053-050450-350.....	5/10	R056-100000-31.....	5/18	R057-050360-350.....	5/11	R058-050360-125.....	4/9
R053-050450-352.....	5/10	R056-100000-32.....	5/18	R057-050360-352.....	5/11	R058-050360-268.....	4/12
R053-050450-354.....	5/10	R056-100000-33.....	5/18	R057-050360-354.....	5/11	R058-050360-310.....	4/12
R053-050450-360.....	5/10	R056-100000-34.....	5/18	R057-050360-360.....	5/11	R058-050360-312.....	4/12
R053P-050330-350.....	5/10	R056-100000-41.....	5/18	R057-050360-410.....	4/14	R058-050360-314.....	4/12
R053P-050330-352.....	5/10	R056-100000-42.....	5/18	R057-050360-412.....	4/14	R058-050360-318.....	4/13
R053P-050330-354.....	5/10	R056-100000-43.....	5/18	R057-050450-110.....	4/9	R058-050360-320.....	4/13
R053P-050330-360.....	5/10	R056-100330-00.....	5/18	R057-050450-112.....	4/9	R058-050360-350.....	5/11
R053P-050360-350.....	5/10	R056-100330-01.....	5/18	R057-050450-113.....	4/9	R058-050360-352.....	5/11
R053P-050360-352.....	5/10	R056-100330-02.....	5/18	R057-050450-114.....	4/10	R058-050360-354.....	5/11
R053P-050360-354.....	5/10	R056-100330-03.....	5/18	R057-050450-116.....	4/10	R058-050360-360.....	5/11
R053P-050360-360.....	5/10	R056-100330-04.....	5/18	R057-050450-118.....	4/10	R058-050360-410.....	4/14
R053P-050450-350.....	5/10	R056-100330-11.....	5/18	R057-050450-120.....	4/10	R058-050360-412.....	4/14
R053P-050450-352.....	5/10	R056-100330-12.....	5/18	R057-050450-122.....	4/9	R058-050450-110.....	4/9
R053P-050450-354.....	5/10	R056-100330-13.....	5/18	R057-050450-125.....	4/9	R058-050450-112.....	4/9
R053P-050450-360.....	5/10	R056-100330-14.....	5/18	R057-050450-268.....	4/12	R058-050450-113.....	4/9
R055-100330-01.....	5/17	R056-100330-21.....	5/18	R057-050450-310.....	4/12	R058-050450-114.....	4/10
R055-100330-02.....	5/17	R056-100330-22.....	5/18	R057-050450-312.....	4/12	R058-050450-116.....	4/10
R055-100330-03.....	5/17	R056-100330-23.....	5/18	R057-050450-314.....	4/12	R058-050450-118.....	4/10
R055-100330-04.....	5/17	R056-100330-31.....	5/18	R057-050450-316.....	4/13	R058-050450-120.....	4/10
R055-100330-11.....	5/17	R056-100330-32.....	5/18	R057-050450-318.....	4/13	R058-050450-122.....	4/9
R055-100330-12.....	5/17	R056-100330-33.....	5/18	R057-050450-320.....	4/13	R058-050450-125.....	4/9
R055-100330-13.....	5/17	R056-100330-34.....	5/18	R057-050450-350.....	5/11	R058-050450-268.....	4/12
R055-100330-21.....	5/17	R056-100330-41.....	5/18	R057-050450-352.....	5/11	R058-050450-310.....	4/12
R055-100330-22.....	5/17	R056-100330-42.....	5/18	R057-050450-354.....	5/11	R058-050450-312.....	4/12
R055-100330-23.....	5/17	R056-100330-43.....	5/18	R057-050450-360.....	5/11	R058-050450-314.....	4/12
R055-100330-31.....	5/17	R057-050330-110.....	4/9	R057-050450-410.....	4/14	R058-050450-316.....	4/13
R055-100330-32.....	5/17	R057-050330-112.....	4/9	R057-050450-412.....	4/14	R058-050450-318.....	4/13
R055-100330-33.....	5/17	R057-050330-113.....	4/9	R057-100330-710.....	4/11	R058-050450-320.....	4/13
R055-100330-34.....	5/17	R057-050330-114.....	4/10	R057-100330-810.....	4/15	R058-050450-350.....	5/11
R055-100330-41.....	5/17	R057-050330-116.....	4/10	R057-100360-710.....	4/11	R058-050450-352.....	5/11
R055-100330-42.....	5/17	R057-050330-118.....	4/10	R057-100360-810.....	4/15	R058-050450-354.....	5/11
R055-100330-43.....	5/17	R057-050330-120.....	4/10	R057-100450-710.....	4/11	R058-050450-360.....	5/11
R055-100330-44.....	5/17	R057-050330-122.....	4/9	R057-100450-810.....	4/15	R058-050450-410.....	4/14
R056-050000-00.....	5/16	R057-050330-125.....	4/9	R058-050330-110.....	4/9	R058-050450-412.....	4/14
R056-050000-01.....	5/16	R057-050330-268.....	4/12	R058-050330-112.....	4/9	R058-0531-361.....	5/12
R056-050000-02.....	5/16	R057-050330-310.....	4/12	R058-050330-113.....	4/9	R058-0533-350.....	5/9
R056-050000-11.....	5/16	R057-050330-312.....	4/12	R058-050330-114.....	4/10	R058-0533-352.....	5/9
R056-050000-12.....	5/16	R057-050330-314.....	4/12	R058-050330-116.....	4/10	R058-0533-354.....	5/9
R056-050000-21.....	5/16	R057-050330-316.....	4/13	R058-050330-118.....	4/10	R058-0533-360.....	5/9
R056-050000-22.....	5/16	R057-050330-318.....	4/13	R058-050330-120.....	4/10	R058-0545-350.....	5/9
R056-050000-41.....	5/16	R057-050330-320.....	4/13	R058-050330-122.....	4/9	R058-0545-352.....	5/9
R056-050000-42.....	5/16	R057-050330-350.....	5/11	R058-050330-125.....	4/9	R058-0545-354.....	5/9
R056-050330-00.....	5/16	R057-050330-352.....	5/11	R058-050330-268.....	4/12	R058-100330-710.....	4/11
R056-050330-01.....	5/16	R057-050330-354.....	5/11	R058-050330-310.....	4/12	R058-100330-810.....	4/15
R056-050330-02.....	5/16	R057-050330-360.....	5/11	R058-050330-312.....	4/12	R058-100360-710.....	4/11
R056-050330-11.....	5/16	R057-050330-410.....	4/14	R058-050330-314.....	4/12	R058-100360-810.....	4/15
R056-050330-12.....	5/16	R057-050330-412.....	4/14	R058-050330-316.....	4/13	R058-100450-710.....	4/11
R056-050330-21.....	5/16	R057-050360-110.....	4/9	R058-050330-318.....	4/13	R058-100450-810.....	4/15

R059-050330-350.....	5/11	R061-050450-004.....	6/2	R066-000000-012.....	6/15	R066-050450-521.....	6/14
R059-050330-352.....	5/11	R061-050450-005.....	6/2	R066-000000-500.....	6/12	R066-050450-601.....	6/12
R059-050330-354.....	5/11	R062-050000-001.....	6/6	R066-000000-600.....	6/12	R066-050450-603.....	6/13
R059-050330-360.....	5/11	R062-050000-002.....	6/6	R066-000200-501.....	6/12	R066-050450-607.....	6/12
R059-050360-350.....	5/11	R062-050000-003.....	6/6	R066-000200-503.....	6/13	R066-050450-608.....	6/13
R059-050360-352.....	5/11	R062-050000-004.....	6/6	R066-000200-507.....	6/12	R066-050450-609.....	6/13
R059-050360-354.....	5/11	R062-050000-005.....	6/6	R066-000200-508.....	6/13	R066-050450-610.....	6/14
R059-050360-360.....	5/11	R062-050000-006.....	6/6	R066-000200-509.....	6/13	R066-050450-621.....	6/14
R059-050450-350.....	5/11	R062-050320-000.....	6/6	R066-000200-510.....	6/14	R067-000000-700.....	6/16
R059-050450-352.....	5/11	R062-050320-001.....	6/6	R066-000200-521.....	6/14	R067-000340-709.....	6/16
R059-050450-354.....	5/11	R062-050320-002.....	6/6	R066-000340-501.....	6/12	R067-000340-713.....	6/16
R059-050450-360.....	5/11	R062-050320-003.....	6/6	R066-000340-503.....	6/13	R067-000340-721.....	6/16
R059-0533-350.....	5/9	R062-050320-004.....	6/6	R066-000340-507.....	6/12	R067-000340-722.....	6/16
R059-0533-352.....	5/9	R062-050320-005.....	6/6	R066-000340-508.....	6/13	R067-000340-723.....	6/16
R059-0533-354.....	5/9	R062-050320-006.....	6/6	R066-000340-509.....	6/13	R067-000340-724.....	6/16
R059-0533-360.....	5/9	R062-050320-099.....	6/6	R066-000340-510.....	6/14	R067-050340-001.....	6/10
R059-0545-350.....	5/9	R062-050330-001.....	6/1	R066-000340-521.....	6/14	R067-050340-002.....	6/10
R059-0545-352.....	5/9	R062-050330-002.....	6/1	R066-000450-501.....	6/12	R067-050340-003.....	6/10
R059-0545-354.....	5/9	R062-050330-003.....	6/1	R066-000450-503.....	6/13	R067-050340-004.....	6/10
R059-100-17.....	5/19	R062-050330-004.....	6/1	R066-000450-507.....	6/12	R067-050340-005.....	6/10
R059-100-25.....	5/19	R062-050330-005.....	6/1	R066-000450-508.....	6/13	R067-050340-700.....	6/16
R059-100-45.....	5/19	R062-050450-001.....	6/1	R066-000450-509.....	6/13	R068-030340-003.....	6/11
R059-100-60.....	5/19	R062-050450-002.....	6/1	R066-000450-510.....	6/14	R068-030340-010.....	6/11
R059-101-17.....	5/19	R062-050450-003.....	6/1	R066-000450-521.....	6/14	R068-030340-012.....	6/11
R059-101-25.....	5/19	R062-050450-004.....	6/1	R066-050200-000.....	6/15	R070-000040-003.....	9/1
R059-101-45.....	5/19	R062-050450-005.....	6/1	R066-050200-001.....	6/15	R070-028250-008.....	10/22
R059-101-60.....	5/19	R063-050330-001.....	6/3	R066-050200-501.....	6/12	R070-028330-008.....	10/22
R059-102-01.....	5/19	R063-050330-002.....	6/3	R066-050200-503.....	6/13	R070-030330-416.....	
R059-103-01.....	5/19	R063-050330-003.....	6/3	R066-050200-507.....	6/12	7/6, 10/25
R060-028330-001.....	10/20	R063-050330-004.....	6/3	R066-050200-508.....	6/13	R070-030340-204.....	
R060-000000-000.....	6/1	R063-050330-005.....	6/3	R066-050200-509.....	6/13	7/5, 10/26
R060-028250-001.....	10/20	R063-050450-001.....	6/3	R066-050200-510.....	6/14	R070-030340-216.....	
R060-028250-002.....	10/20	R063-050450-002.....	6/3	R066-050200-521.....	6/14	7/5, 10/26
R060-028250-003.....	10/20	R063-050450-003.....	6/3	R066-050200-601.....	6/12	R070-030340-304.....	
R060-028250-004.....	10/20	R063-050450-004.....	6/3	R066-050200-603.....	6/13	7/6, 10/24
R060-028250-005.....	10/20	R063-050450-005.....	6/3	R066-050200-607.....	6/12	R070-030340-316.....	
R060-028330-002.....	10/20	R064-050000-001.....	6/4, 7/6,	R066-050200-608.....	6/13	7/6, 10/24
R060-028330-003.....	10/20	10/25	R066-050200-609.....	6/13	R070-035240-116.....	
R060-028330-004.....	10/20	R064-050000-002.....	6/4	R066-050200-610.....	6/14	7/4, 10/25
R060-028330-005.....	10/20	R064-050000-006.....	6/5	R066-050200-621.....	6/14	R070-050200-01.....	6/19
R060-040040-003.....	6/7	R064-050000-010.....	6/5	R066-050340-000.....	6/15	R070-050200-02.....	6/19
R060-040040-005.....	6/7	R064-050000-011.....	6/5	R066-050340-001.....	6/15	R070-050200-03.....	6/19
R060-040040-203.....	6/7	R064-050330-001.....	6/4	R066-050340-501.....	6/12	R070-050200-04.....	6/19
R060-040040-205.....	6/7	R064-050330-002.....	6/4	R066-050340-503.....	6/13	R070-050200-05.....	6/19
R060-050040-003.....	6/7	R064-050330-003.....	6/4	R066-050340-507.....	6/12	R070-050200-06.....	6/19
R060-050040-005.....	6/7	R064-050330-004.....	6/4	R066-050340-508.....	6/13	R070-050200-07.....	6/19
R060-050330-001.....	6/1	R064-050330-005.....	6/4	R066-050340-509.....	6/13	R070-050330-001.....	7/3
R060-050330-002.....	6/1	R065-020080-003.....	6/17	R066-050340-510.....	6/14	R070-050330-002.....	7/3
R060-050330-003.....	6/1	R065-020080-005.....	6/17	R066-050340-521.....	6/14	R070-050330-004.....	7/3
R060-050330-004.....	6/1	R065-020080-103.....	6/17	R066-050340-601.....	6/12	R070-050330-004D.....	7/1
R060-050330-005.....	6/1	R065-020080-105.....	6/17	R066-050340-603.....	6/13	R070-050330-012.....	7/3
R060-050450-001.....	6/1	R065-040000-003.....	6/17	R066-050340-607.....	6/12	R070-050330-016.....	7/3
R060-050450-002.....	6/1	R065-040000-005.....	6/17	R066-050340-608.....	6/13	R070-050330-032.....	7/3
R060-050450-003.....	6/1	R065-040000-103.....	6/17	R066-050340-609.....	6/13	R070-050330-048.....	7/3
R060-050450-004.....	6/1	R065-040000-105.....	6/17	R066-050340-610.....	6/14	R070-050330-049.....	7/3
R060-050450-005.....	6/1	R065-040125-003.....	6/17	R066-050340-621.....	6/14	R070-050330-116.....	7/4
R060-080040-003.....	6/7	R065-040125-005.....	6/17	R066-050450-000.....	6/15	R070-050330-416.....	7/6
R060-080040-005.....	6/7	R065-040125-103.....	6/17	R066-050450-001.....	6/15	R070-050340-204.....	7/5
R061-050340-002.....	6/2	R065-040125-105.....	6/17	R066-050450-501.....	6/12	R070-050340-216.....	7/5
R061-050340-003.....	6/2	R065-040285-003.....	6/17	R066-050450-503.....	6/13	R070-050340-304.....	7/6
R061-050340-004.....	6/2	R065-040285-005.....	6/17	R066-050450-507.....	6/12	R070-050340-316.....	7/6
R061-050340-005.....	6/2	R065-040285-103.....	6/17	R066-050450-508.....	6/13	R070-050450-116.....	7/4
R061-050450-002.....	6/2	R065-040285-105.....	6/17	R066-050450-509.....	6/13	R070-050500-049.....	7/3
R061-050450-003.....	6/2	R066-000000-002.....	6/15	R066-050450-510.....	6/14	R070-100330-116.....	7/4

R070-100330-416.....	7/6	R075-028330-012.....	10/23	R091-050340-003.....	9/3	R102M-030180-242.....	10/11
R070-100340-204.....	7/5	R075-028330-016.....	10/23	R091-050340-005.....	9/4	R102M-030210-210.....	10/9
R070-100340-216.....	7/5	R075-050330-004.....	7/2	R091-100330-005.....	9/2	R102M-030210-212.....	10/9
R070-100340-304.....	7/6	R075-050330-007.....	7/8	R091-100380-005.....	9/3	R102M-030210-214.....	10/9
R070-100340-316.....	7/6	R075-050330-009.....	7/8	R092-050340-003.....	9/3	R102M-030210-220.....	10/9
R070-100450-116.....	7/4	R075-050330-012.....	7/8	R092-050340-005.....	9/4	R102M-030210-222.....	10/11
R071-000000-000		R075-050330-014.....	7/8	R092-100380-005.....	9/3	R102M-030210-224.....	10/11
.....	7/3, 10/22	R075-050330-015.....	7/8	R093-050470-001.....	9/5	R102M-030210-230.....	10/11
R071-028250-008.....	10/22	R075-050330-018.....	7/8	R093-050550-001.....	9/5	R102M-030210-242.....	10/11
R071-028330-008.....	10/22	R075-050340-000.....	7/7	R094-050360-001.....	9/2	R102M-030330-210.....	10/9
R071-050330-001.....	7/3	R075-050340-016.....	7/7	R094-100360-001.....	9/2	R102M-030330-212.....	10/9
R071-050330-002.....	7/3	R075-050450-012.....	7/8	R099-000250-003.....	9/6	R102M-030330-214.....	10/9
R071-050330-004.....	7/3	R075-050450-014.....	7/8	R100-030180-110.....	10/13	R102M-030330-220.....	10/9
R071-050330-012.....	7/3	R075-050450-015.....	7/8	R100-030180-112.....	10/13	R102M-030330-222.....	10/11
R071-050330-016.....	7/3	R075-050450-018.....	7/8	R100-030180-114.....	10/13	R102M-030330-224.....	10/11
R071-050330-032.....	7/3	R076-000000-200		R100-030180-116.....	10/14	R102M-030330-230.....	10/11
R071-050330-048.....	7/3	7/5, 10/26	R100-030180-118.....	10/14	R102M-030330-242.....	10/11
R071-050330-049.....	7/3	R076-000000-300		R100-030180-210.....	10/9	R103-030180-210.....	10/9
R071-050500-049.....	7/3	7/6, 10/24	R100-030180-212.....	10/9	R103-030180-212.....	10/9
R072-000000-000.....	7/1, 7/3,	R076-030340-204.....	7/5	R100-030180-214.....	10/9	R103-030180-214.....	10/9
.....	10/22	R076-030340-216.....	7/5	R100-030180-220.....	10/9	R103-030180-220.....	10/9
R072-028250-008.....	10/22	R076-030340-304.....	7/6	R100-030180-222.....	10/11	R103-030180-222.....	10/11
R072-028330-008.....	10/22	R076-030340-316.....	7/6	R100-030180-224.....	10/11	R103-030180-224.....	10/11
R072-050330-001.....	7/3	R076-050340-204.....	7/5	R100-030180-230.....	10/11	R103-030180-230.....	10/11
R072-050330-002.....	7/3	R076-050340-216.....	7/5	R100-030180-242.....	10/11	R103-030180-242.....	10/11
R072-050330-004.....	7/3	R076-050340-304.....	7/6	R100-030180-310.....	10/15	R103-030210-210.....	10/9
R072-050330-004D.....	7/1	R076-050340-316.....	7/6	R100-030180-312.....	10/15	R103-030210-212.....	10/9
R072-050330-012.....	7/3	R076-100340-204.....	7/5	R100-030210-110.....	10/13	R103-030210-214.....	10/9
R072-050330-016.....	7/3	R076-100340-216.....	7/5	R100-030210-112.....	10/13	R103-030210-220.....	10/9
R072-050330-032.....	7/3	R076-100340-304.....	7/6	R100-030210-114.....	10/13	R103-030210-222.....	10/11
R072-050330-048.....	7/3	R076-100340-316.....	7/6	R100-030210-116.....	10/14	R103-030210-224.....	10/11
R072-050330-049.....	7/3	R078-000000-100		R100-030210-118.....	10/14	R103-030210-230.....	10/11
R072-050500-049.....	7/3	7/4, 10/25	R100-030210-210.....	10/9	R103-030210-242.....	10/11
R073-000000-000.....	7/3	R078-000000-199.....	7/4	R100-030210-212.....	10/9	R103-030330-210.....	10/9
R073-050330-001.....	7/3	R078-050330-116.....	7/4	R100-030210-214.....	10/9	R103-030330-212.....	10/9
R073-050330-002.....	7/3	R078-100330-116.....	7/4	R100-030210-220.....	10/9	R103-030330-214.....	10/9
R073-050330-004.....	7/3	R079-000000-100.....	7/4	R100-030210-222.....	10/11	R103-030330-220.....	10/9
R073-050330-012.....	7/3	R079-000000-199.....	7/4	R100-030210-224.....	10/11	R103-030330-222.....	10/11
R073-050330-016.....	7/3	R079-000000-200		R100-030210-230.....	10/11	R103-030330-224.....	10/11
R073-050330-032.....	7/3	7/5, 10/26	R100-030210-242.....	10/11	R103-030330-230.....	10/11
R073-050330-048.....	7/3	R079-030330-416		R100-030210-310.....	10/15	R103-030330-242.....	10/11
R073-050330-049.....	7/3	7/6, 10/25	R100-030210-312.....	10/15	R103P-030180-210.....	10/9
R073-050500-049.....	7/3	R079-030340-204.....	7/5	R100-030330-110.....	10/13	R103P-030180-212.....	10/9
R074-050330-016.....	7/2	R079-030340-216.....	7/5	R100-030330-112.....	10/13	R103P-030180-214.....	10/9
R074-050450-016.....	7/2	R079-050330-116.....	7/4	R100-030330-114.....	10/13	R103P-030180-220.....	10/9
R075-020055-001.....	7/9	R079-050330-416.....	7/6	R100-030330-116.....	10/14	R103P-030180-222.....	10/11
R075-020070-001.....	7/9	R079-050340-204.....	7/5	R100-030330-118.....	10/14	R103P-030180-224.....	10/11
R075-020080-001.....	7/9	R079-050340-216.....	7/5	R100-030330-210.....	10/9	R103P-030180-230.....	10/11
R075-020100-001.....	7/9	R079-100330-116.....	7/4	R100-030330-212.....	10/9	R103P-030180-242.....	10/11
R075-020120-001.....	7/9	R079-100340-416.....	7/6	R100-030330-214.....	10/9	R103P-030210-210.....	10/9
R075-020130-001.....	7/9	R079-100340-204.....	7/5	R100-030330-220.....	10/9	R103P-030210-212.....	10/9
R075-020140-001.....	7/9	R079-100340-216.....	7/5	R100-030330-222.....	10/11	R103P-030210-214.....	10/9
R075-020150-001.....	7/9	R080-020100-001.....	7/10	R100-030330-224.....	10/11	R103P-030210-220.....	10/9
R075-020170-001.....	7/9	R080-020120-001.....	7/10	R100-030330-230.....	10/11	R103P-030210-222.....	10/11
R075-020180-001.....	7/9	R080-020150-001.....	7/10	R100-030330-242.....	10/11	R103P-030210-224.....	10/11
R075-020200-001.....	7/9	R080-020600-201.....	8/1	R100-030330-310.....	10/15	R103P-030210-230.....	10/11
R075-020230-001.....	7/9	R080-027100-001.....	7/10	R100-030330-312.....	10/15	R103P-030210-242.....	10/11
R075-020390-000.....	7/7	R080-027120-001.....	7/10	R102M-030180-210.....	10/9	R103P-030330-210.....	10/9
R075-027100-001.....	7/9	R080-027150-001.....	7/10	R102M-030180-212.....	10/9	R103P-030330-212.....	10/9
R075-027120-001.....	7/9	R081-050330-001.....	8/2	R102M-030180-214.....	10/9	R103P-030330-214.....	10/9
R075-027150-001.....	7/9	R090-028250-001.....	10/21	R102M-030180-220.....	10/9	R103P-030330-220.....	10/9
R075-027170-001.....	7/9	R090-028330-001.....	10/21	R102M-030180-222.....	10/11	R103P-030330-222.....	10/11
R075-028250-012.....	10/23	R090-050330-001.....	9/1	R102M-030180-224.....	10/11	R103P-030330-224.....	10/11
R075-028250-016.....	10/23	R090-050450-001.....	9/1	R102M-030180-230.....	10/11	R103P-030330-230.....	10/11

R103P-030330-242.....	10/11	R107-030330-214.....	10/10	R119-93527-12.....	11/9	R150-030330-350.....	10/18
R104-030180-110.....	10/13	R107-030330-220.....	10/10	R119-93527-13.....	11/5	R150-030330-352.....	10/18
R104-030180-112.....	10/13	R107-030330-222.....	10/12	R119-93527-14.....	11/8	R150-030330-354.....	10/18
R104-030180-114.....	10/13	R107-030330-224.....	10/12	R119-93527-15.....	11/8	R150-030330-360.....	10/18
R104-030180-116.....	10/14	R107-030330-230.....	10/12	R119-93527-16.....	11/4	R151-030210-350.....	10/18
R104-030180-118.....	10/14	R107-030330-242.....	10/12	R119-93527-17.....	11/4	R151-030210-352.....	10/18
R104-030180-210.....	10/9	R108-030180-210.....	10/10	R119-93527-18.....	11/6	R151-030210-354.....	10/18
R104-030180-212.....	10/9	R108-030180-212.....	10/10	R119-93527-19.....	11/6	R151-030210-360.....	10/18
R104-030180-214.....	10/9	R108-030180-214.....	10/10	R119-93527-20.....	11/11	R151-030330-350.....	10/18
R104-030180-220.....	10/9	R108-030180-220.....	10/10	R119-93527-21.....	11/6	R151-030330-352.....	10/18
R104-030180-222.....	10/11	R108-030180-222.....	10/12	R120-060000-001.....	12/12	R151-030330-354.....	10/18
R104-030180-224.....	10/11	R108-030180-224.....	10/12	R120-060000-002.....	12/12	R151-030330-360.....	10/18
R104-030180-230.....	10/11	R108-030180-230.....	10/12	R120-060330-001.....	12/12	R153-030210-350.....	10/18
R104-030180-242.....	10/11	R108-030180-242.....	10/12	R120-065340-001.....	12/12	R153-030210-352.....	10/18
R104-030180-310.....	10/15	R108-030210-210.....	10/10	R121-050320-01.....	12/13	R153-030210-354.....	10/18
R104-030180-312.....	10/15	R108-030210-212.....	10/10	R121-100330-01.....	12/13	R153-030210-360.....	10/18
R104-030210-110.....	10/13	R108-030210-214.....	10/10	R122-030045-000.....	12/15	R153-030330-350.....	10/18
R104-030210-112.....	10/13	R108-030210-220.....	10/10	R122-030055-000.....	12/15	R153-030330-352.....	10/18
R104-030210-114.....	10/13	R108-030210-222.....	10/12	R122-080080-000.....	12/15	R153-030330-354.....	10/18
R104-030210-116.....	10/14	R108-030210-224.....	10/12	R122-100100-000.....	12/15	R153-030330-360.....	10/18
R104-030210-118.....	10/14	R108-030210-230.....	10/12	R122-190056-000.....	12/14	R153P-030210-350.....	10/18
R104-030210-210.....	10/9	R108-030210-242.....	10/12	R122-200180-000.....	12/15	R153P-030210-352.....	10/18
R104-030210-212.....	10/9	R108-030330-210.....	10/10	R122-200180-199.....	12/15	R153P-030210-354.....	10/18
R104-030210-214.....	10/9	R108-030330-212.....	10/10	R122-250056-000.....	12/14	R153P-030210-360.....	10/18
R104-030210-220.....	10/9	R108-030330-214.....	10/10	R122-250060-000.....	12/15	R153P-030330-350.....	10/18
R104-030210-222.....	10/11	R108-030330-220.....	10/10	R122-250070-000.....	12/15	R153P-030330-352.....	10/18
R104-030210-224.....	10/11	R108-030330-222.....	10/12	R122-250170-000.....	12/14	R153P-030330-354.....	10/18
R104-030210-230.....	10/11	R108-030330-224.....	10/12	R122-250170-001.....	12/14	R153P-030330-360.....	10/18
R104-030210-242.....	10/11	R108-030330-230.....	10/12	R139-070210-001.....	13/1	R157-030210-350.....	10/19
R104-030210-310.....	10/15	R108-030330-242.....	10/12	R139-070300-011.....	13/1	R157-030210-352.....	10/19
R104-030210-312.....	10/15	R110-100178-030.....	11/1	R147-030180-110.....	10/13	R157-030210-354.....	10/19
R104-030330-110.....	10/13	R111-060050-003.....	11/2	R147-030180-112.....	10/13	R157-030210-360.....	10/19
R104-030330-112.....	10/13	R111-060050-006.....	11/2	R147-030180-114.....	10/13	R157-030330-350.....	10/19
R104-030330-114.....	10/13	R111-110050-003.....	11/2	R147-030180-116.....	10/14	R157-030330-352.....	10/19
R104-030330-116.....	10/14	R111-110050-006.....	11/2	R147-030180-118.....	10/14	R157-030330-354.....	10/19
R104-030330-118.....	10/14	R111-130050-003.....	11/2	R147-030210-110.....	10/13	R157-030330-360.....	10/19
R104-030330-210.....	10/9	R111-130050-006.....	11/2	R147-030210-112.....	10/13	R158-030210-350.....	10/19
R104-030330-212.....	10/9	R112-060070-003.....	11/2	R147-030210-114.....	10/13	R158-030210-352.....	10/19
R104-030330-214.....	10/9	R112-060070-006.....	11/2	R147-030210-116.....	10/14	R158-030210-354.....	10/19
R104-030330-220.....	10/9	R112-060070-606.....	11/2	R147-030210-118.....	10/14	R158-030210-360.....	10/19
R104-030330-222.....	10/11	R112-060100-003.....	11/2	R147-030330-110.....	10/13	R158-030330-350.....	10/19
R104-030330-224.....	10/11	R112-060100-006.....	11/2	R147-030330-112.....	10/13	R158-030330-352.....	10/19
R104-030330-230.....	10/11	R112-060100-606.....	11/2	R147-030330-114.....	10/13	R158-030330-354.....	10/19
R104-030330-242.....	10/11	R112-110070-003.....	11/2	R147-030330-116.....	10/14	R158-030330-360.....	10/19
R104-030330-310.....	10/15	R112-110070-006.....	11/2	R147-030330-118.....	10/14	R158-0533-350.....	10/17
R104-030330-312.....	10/15	R112-110070-606.....	11/2	R148-030180-110.....	10/13	R158-0533-352.....	10/17
R107-030180-210.....	10/10	R112-110100-003.....	11/2	R148-030180-112.....	10/13	R158-0533-354.....	10/17
R107-030180-212.....	10/10	R112-110100-006.....	11/2	R148-030180-114.....	10/13	R158-0533-360.....	10/17
R107-030180-214.....	10/10	R112-110100-606.....	11/2	R148-030180-116.....	10/14	R159-030210-350.....	10/19
R107-030180-220.....	10/10	R116-050330-003.....	11/12	R148-030180-118.....	10/14	R159-030210-352.....	10/19
R107-030180-222.....	10/12	R116-050330-004.....	11/12	R148-030210-110.....	10/13	R159-030210-354.....	10/19
R107-030180-224.....	10/12	R116-050330-103.....	11/12	R148-030210-112.....	10/13	R159-030210-360.....	10/19
R107-030180-230.....	10/12	R117-000000-500.....	11/13	R148-030210-114.....	10/13	R159-030330-350.....	10/19
R107-030180-242.....	10/12	R117-050330-501.....	11/13	R148-030210-116.....	10/14	R159-030330-352.....	10/19
R107-030210-210.....	10/10	R117-050330-504.....	11/13	R148-030210-118.....	10/14	R159-030330-354.....	10/19
R107-030210-212.....	10/10	R118-000000-500.....	11/13	R148-030330-110.....	10/13	R159-030330-360.....	10/19
R107-030210-214.....	10/10	R119-93527-01.....	11/4	R148-030330-112.....	10/13	R159-0533-350.....	10/17
R107-030210-220.....	10/10	R119-93527-04.....	11/3	R148-030330-114.....	10/13	R159-0533-352.....	10/17
R107-030210-222.....	10/12	R119-93527-05.....	11/9	R148-030330-116.....	10/14	R159-0533-354.....	10/17
R107-030210-224.....	10/12	R119-93527-06.....	11/7	R148-030330-118.....	10/14	R159-0533-360.....	10/17
R107-030210-230.....	10/12	R119-93527-07.....	11/10	R150-030210-350.....	10/18	R210-040281-000.....	12/3
R107-030210-242.....	10/12	R119-93527-08.....	11/10	R150-030210-352.....	10/18	R210-040281-030.....	12/3
R107-030330-210.....	10/10	R119-93527-10.....	11/7	R150-030210-354.....	10/18	R210-040281-130.....	12/3
R107-030330-212.....	10/10	R119-93527-11.....	11/9	R150-030210-360.....	10/18	R210-040305-00.....	12/3

R210-040306-00.....	12/3	15/18-15/19	RP101.....	16/15	RZ5074-01.....	17/3, 17/7
R210-050274-000.....	12/3	R900-000000-05	14/2	RP101-L01.....	16/10	RZ5077-01.....	17/3
R210-050274-030.....	12/3	R900-000000-06	14/2, 15/7,	RP101-L02.....	16/10	RZOOM-L01.....	15/7, 15/13
R210-050274-130.....	12/3	15/18-15/19	RPP600 RI	18/4		
R210-050281-001.....	12/3	R900-000000-07.....	14/2, 15/7,	RT0449-01	16/8, 16/14		
R210-050305-00.....	12/3	15/18-15/19	RT0454-01	16/8, 16/14		
R210-050306-00.....	12/3	R900-000000-08	14/2	RT0500-01	16/3		
R211-040281-000.....	12/3	R900-000000-09	14/2	RT0501-01	16/3		
R211-040281-030.....	12/3	R900-000000-11	14/2	RT0502-01	16/3		
R211-040281-130.....	12/3	R900-000000-13	14/2	RT0503-01	16/3		
R211-050274-000.....	12/3	R900-000000-15	14/2	RT0504-01	16/3		
R211-050274-001.....	12/3	R900-000000-16	14/2	RT0505-01	16/3		
R211-050274-030.....	12/3	R900-000000-21.....	14/2	RT0506-01	16/3		
R211-050274-130.....	12/3	R900-000000-31	14/2	RT0550-01	16/3		
R211-075211-030.....	12/4	R900-035180-00.....	14/1	RT0551-01	16/3		
R212-035248-101	12/8	R900-035230-00.....	14/1	RT0552-01.....	16/3		
R212-038300-000	12/7	R900-035300-00.....	14/1	RT0553-01	16/3		
R212-040300-000	12/7	R900-035350-00.....	14/1	RT0554-01	16/3		
R212-075211-030.....	12/4	R900-048180-00.....	14/1, 15/7	RUP100-L01	16/11		
R213-037260-000	12/6	R900-048230-00.....	14/1, 15/7	RURO-L01.....	15/7, 15/13		
R213-037260-030.....	12/6	R900-048250-00.....	14/1	RXBO-L03	15/18		
R213-050260-000	12/6	R900-048300-00	14/1, 15/7	RXL300-L01.....	15/18		
R213-050300-000.....	12/6	R900-048350-00.....	14/1	RXL300-L03	15/18		
R213-054260-000	12/9	R901-035180-00.....	14/1	RZ0106-01.....	16/9, 16/15		
R213-054260-030	12/9	R901-035230-00	14/1	RZ0123-01	16/12, 16/15		
R213-065250-030	12/9	R901-035300-00.....	14/1	RZ0175-01	17/13		
R213-065300-000	12/9	R901-035350-00.....	14/1	RZ0223-01	16/3		
R214-060193-000	12/5	R901-048180-00	14/1, 15/18	RZ0260.....	17/3		
R214-060193-030	12/5	R901-048230-00.....	14/1, 15/18	RZ0280.....	17/3		
R214-070000-000	12/10	R901-048250-00.....	14/1	RZ0293.....	17/3		
R214-070000-030	12/10	R901-048300-00	14/1, 15/18	RZ0449-01.....	16/9-16/14		
R214-070200-030	12/10	R901-048350-00.....	14/1	RZ0452-01	17/3, 17/7,		
R214-080193-000	12/5	R940-5130-160	7/9	17/10-17/12		
R214-080193-030	12/5	R940-5130-190	7/9	RZ0454-01.....	16/9-16/14		
R292-017400-001.....	12/11	R940-5130-235.....	7/9	RZ0499-01	17/3, 17/7		
R292-017400-002	12/11	RA106-L01.....	16/9	RZ0536	17/3, 17/7,		
R292-017400-003	12/11	RA127-L01	16/8	17/10-17/12		
R292-017400-004.....	12/11	RAPUH302-L01.....	16/3	RZ0545-01	16/9, 16/15		
R292-017400-011.....	12/11	RCCB-L02	15/13	RZ0553-01	16/10, 16/13		
R292-017400-021.....	12/11	RF102-L04	17/10	RZ0554-01	16/10,		
R292-017400-022.....	12/11	RF104-L01.....	17/11	16/12-16/13, 16/15		
R292-023400-001	12/11	RF104-L02	17/11	RZ0555-01	16/10,		
R292-023400-002.....	12/11	RF128-L01	17/7	16/12-16/13, 16/15		
R292-023400-004	12/11	RFM134-L01.....	17/3	RZ0556-01.....	16/10, 16/15		
R292-023400-011	12/11	RH108	16/15	RZ1406-01	16/11- 16/13		
R292-023400-021.....	12/11	RH108-L01.....	16/12	RZ1415-01.....	17/11-17/12		
R292-023400-022.....	12/11	RHDC1000-L01.....	15/7	RZ1422-01	17/7, 17/10-17/12		
R300-040302-000.....	12/1	RHDC1000-L04.....	15/7	RZ1424-01	16/9, 16/12		
R300-040302-030.....	12/1	RHDC1100-L01.....	15/7	RZ1425-01	16/10		
R395-017450-001	12/16	RHDC1100-L04.....	15/7	RZ1426-01	16/10		
R395-017450-021.....	12/16	RHDC907-L01	15/13	RZ5010-01			
R395-023450-001	12/16	RHDC907-L02	15/13	17/10-17/11, 17/13		
R395-023450-011	12/16	RHDC907-L03	15/13	RZ5020-01			
R395-023450-021	12/16	RHL150.....	15/22	17/10-17/11, 17/13		
R395-030450-001.....	12/16	RHM4-L01.....	16/13	RZ5030-01	17/3, 17/7,		
R396-000360-001.....	12/16	RKeyboard-L01	15/7	17/10-17/11, 17/13		
R396-000360-002	12/16	RLED-L01	15/17	RZ5031-01	17/3, 17/7,		
R900-000000-01	14/2, 15/7,	RLED1000O	15/21	17/10-17/11		
.....	15/18-15/19	RLED1000S	15/21	RZ5044-01.....	17/3, 17/7,		
R900-000000-02.....	14/2, 15/7,	RLED1000W	15/21	17/10-17/11, 17/13		
.....	15/18-15/19	RLED3000O	15/20	RZ5070-01	17/10-17/11		
R900-000000-03	14/2, 15/7,	RLED3000S	15/20	RZ5071-01	17/7		
.....	15/18-15/19	RLED3000T	15/20	RZ5072-01.....	17/3, 17/7,		
R900-000000-04	14/2, 15/7,	RLED3000W.....	15/20	17/10-17/11		

Weitere Kataloge und Prospekte
Other cataloges and prospects

Hauptkatalog Chirurgische Instrumente
General catalog surgical instruments

Titan Instrumente
Titanium instruments

Container Steriltechnik
Container sterilization technique

HERCULES Drahtkneifzange
HERCULES Wire Cutters

Neurochirurgie
Neuro surgery

Orthopädie
Orthopedic



REDA

INSTRUMENTE GMBH

Gänsäcker 34
D-78532 Tuttlingen/Germany
Telefon +49 74 62.94 45-0
Telefax +49 74 62.94 45-20
Internet: www.Reda-Instrumente.de
Email: Info@Reda-Instrumente.de